

Thank you for choosing

Panasonic Omnivision **VHS**

MODEL PV-7200/PV-7400/PV-7450

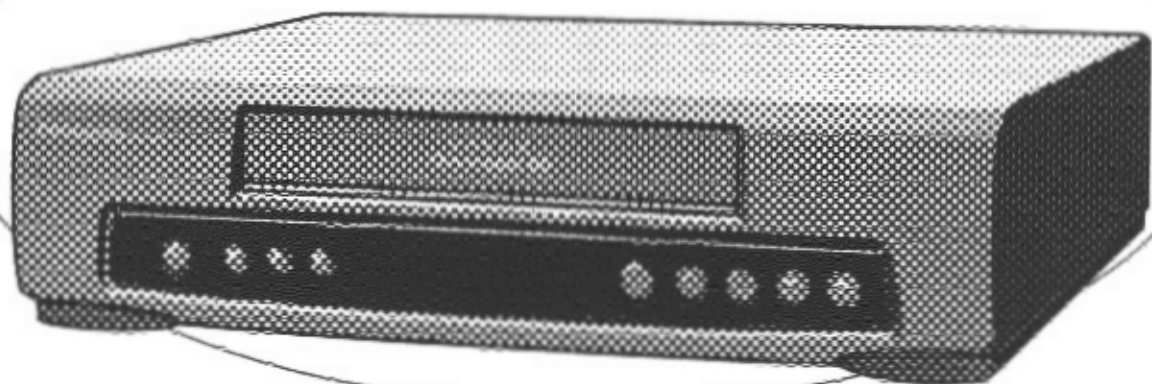

Video Cassette Recorder

Operating Instructions

Please read these instructions carefully before attempting to connect, operate or adjust this product. Save this manual.

Spanish Quick Use Guide is included. (Guía para rápida consulta en español está incluido.)

Quick Use Guide is on the back cover.

P6 ~ P9
Connections

P10 ~ P14
Getting Started

P15 ~ P19
Basic Operation

P20 ~ P26
More You Can Do

P27 ~ Back Cover
Other Information

Things You Should Know

Congratulations

on your purchase of one of the most sophisticated and reliable products on the market today. Used properly, it will bring you and your family years of enjoyment. Please fill in the information at right. The serial number is on the tag located on the back of your VCR.

Date of Purchase _____
Dealer Purchased From _____
Dealer Address _____
Dealer Phone No. _____
Model No. _____
Serial No. _____

Safety Precautions

Warning: To prevent fire or shock hazard, do not expose this equipment to rain or moisture. This video recorder, equipped with the HQ (High Quality) System, is compatible with existing VHS equipment. Only use those tapes with the **VHS** mark. It is recommended that only cassette tapes that have been tested and inspected for use in 2, 4, 6, and 8 hour VCR machines be used.

FCC Warning: Any unauthorized changes or modifications to this equipment would void the user's authority to operate.

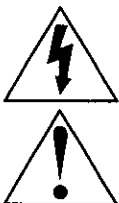
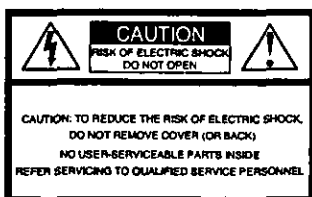

This symbol warns the user that uninsulated voltage within the unit may have sufficient magnitude to cause electric shock. Therefore, it is dangerous to make any kind of contact with any inside part of this unit.

This symbol alerts the user that important literature concerning the operation and maintenance of this unit has been included. Therefore, it should be read carefully in order to avoid any problems.

Table of Contents

| | |
|---|---|
| Things You Should Know | 2 |
| Important Safeguards and Precautions | 3 |
| Unpacking Your VCR • Product Features | 4 |
| VCR and Cassette Information (Record Tab, D.S.T., Head Cleaning, Tape Speeds, Specifications) | 5 |

Connections

| | |
|--|------|
| Basic Connection (Antenna and VCR, VCR and TV) | 6, 7 |
| Additional Connections (CATV, Audio/Video) | 8, 9 |

Getting Started

| | |
|---|--------|
| Location of Controls (Remote Control, VCR) | 10, 11 |
| One Time VCR Setup (On-Screen Language, Channel Memory, Clock Set) | 12, 13 |
| On-Screen Displays (OSD) (Function, Channel, Menu, VCR Status & Clock, Warning) | 14 |

Basic Operation

| | |
|--|--------|
| Playback a Tape (Main Operation, Special Effects, Quality Picture Features) | 15 |
| Record On a Tape (Main Operation, One Touch Record, Channel Selection) | 16 |
| Copying Your Tapes (Dubbing) (Connection, Main Operation, Monitoring, Select Input Mode) | 17 |
| Timer Recording (Main Operation, Cancel, Clear or Replace Program Contents) | 18, 19 |

More You Can Do

| | |
|---|--------|
| Tape Operation (Repeat Play, One Minute Skip, Zero Search, Auto Functions, Index Search) | 20, 21 |
| MTS Broadcast/ VHS Hi-Fi Stereo System (For Model PV-7450 only) (Stereo/SAP/Mono Broadcast, Select Audio Mode) | 22, 23 |
| Multi-Brand Control Feature | 24, 25 |
| Special VCR Features (VCR Lock, Warning Beeper) | 26 |

Other Information

| | |
|--|------------|
| Before Requesting Service (Self-check items) | 27 |
| Service Center List | 28 |
| Warranty | 29 |
| Spanish Quick Use Guide | 30, 31 |
| Quick Use Guide | Back Cover |



Important Safeguards and Precautions

FOR YOUR SAFETY, READ AND RETAIN ALL SAFETY AND OPERATING INSTRUCTIONS. HEED ALL WARNINGS IN THE MANUAL AND ON THE UNIT

INSTALLATION

1 POWER SOURCE CAUTION

Operate only from a power source indicated on the unit or in this manual.

If necessary, have your Electric Utility Service Company or Video Products Dealer verify the power source in your home.

2 POLARIZED OR GROUNDING PLUG

As a safety feature, this Video product comes with either a polarized power cord plug (one blade is wider than the other), or a three-wire grounding type plug.

POLARIZED PLUG CAUTION:

This plug will only fit into an outlet one way. If you cannot fully insert the plug, try reversing it. If it still will not fit, have an electrician install the proper wall outlet. Do not defeat the safety feature by tampering with the plug.

GROUNDING PLUG CAUTION:

This plug will only fit into a three-hole grounding outlet. If necessary, have an electrician install the proper outlet. Do not defeat the safety feature by tampering with the plug.

3 POWER CORD

Make sure power cords are routed so that they are not likely to have anything rest on them, roll over them, or be in the way of walking traffic.

If an extension cord is used, make sure it also has either a polarized or grounded plug and that the cords can be securely connected.

Frayed cords, damaged plugs, and damaged or cracked wire insulation are hazardous and should be replaced by a qualified service technician.

Overloaded outlets and extension cords are fire hazards and should be avoided.

4 DO NOT BLOCK VENTILATION HOLES

Ventilation openings in the cabinet release heat generated during operation. If they are blocked, heat build-up inside the unit can cause failures that may result in a fire hazard or heat damage to cassettes.

For protection, follow these rules:

- Never cover ventilation slots or the unit while in use, or operate the unit when placed on a bed, sofa, rug, or other soft surface.
- Avoid built-in installation, such as a book case or rack, unless proper ventilation is provided.

5 AVOID EXTREMELY HOT LOCATIONS OR SUDDEN TEMPERATURE CHANGES

Do not place the unit over or near any kind of heater or regulator, in direct sunlight, inside a closed vehicle, etc.. Do not move the unit suddenly between areas of extreme temperature variation. If the unit is suddenly moved from a cold place to a warm place, moisture may condense in the unit and on the tape.

6 TO AVOID PERSONAL INJURY

- Do not place unsecured equipment on a sloping surface.
- Support for the unit should be firm, level, and adequately strong.
- An appliance and cart combination should be moved with care. Quick stops, excessive force, and uneven surfaces may cause the appliance and cart combination to overturn.
- Carefully follow all operating instructions and use the manufacturer's recommended accessories when operating this unit or connecting it to any other equipment.



OUTDOOR ANTENNA INSTALLATION

1 SAFE ANTENNA AND CABLE CONNECTION

If an outside antenna or cable system is connected to the equipment, be sure the antenna or cable system is grounded so as to provide some protection against built up static charges and voltage surges. Section 810 of the National Electrical Code, ANSI/NFPA 70 (in Canada, part 1 of the Canadian Electrical Code) provides information with respect to proper grounding of the mast and supporting structure, grounding of the lead-in wire to an antenna discharge unit, size of grounding conductors, location of antenna discharge unit, connection to grounding electrodes and requirements for the grounding electrode.

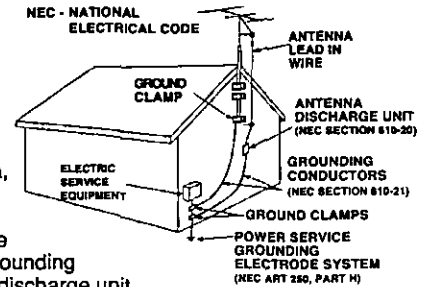

2 KEEP ANTENNA CLEAR OF HIGH VOLTAGE POWER LINES OR CIRCUITS

An outside antenna system should be located well away from power lines, electric light or power circuits and where it will never come into contact with these power sources if it should happen to fall. When installing an outside antenna, extreme care should be taken to avoid touching power lines, circuits or other power sources as this could be fatal. Because of the hazards involved, antenna installation should be left to a professional.

USING THE VIDEO UNIT

If the unit has been in storage or moved to a new location, refer first to the INSTALLATION section of these safeguards.

1 KEEP THIS VIDEO UNIT AWAY FROM WATER OR MOISTURE OF ANY KIND.

2 IF EQUIPMENT IS EXPOSED TO RAIN, MOISTURE, OR STRONG IMPACT, unplug the unit and have it inspected by a qualified service technician before use.

3 DURING AN ELECTRICAL STORM

During a lightning storm, whether indoors or outdoors, or before leaving the unit unused for extended periods of time, disconnect all equipment from the power source as well as the antenna and cable system.

4 WHEN THE UNIT IS PLUGGED IN

- Never expose the unit to rain or water. **DO NOT OPERATE** if liquid has been spilled into the unit. Immediately unplug the unit, and have it inspected by a service technician. Fire and shock hazards can result from electrical shorts caused by liquid contact inside.
- Never drop or push any object through openings in the unit. Some internal parts carry hazardous voltages and contact can cause electric shock or fire hazard.
- Avoid placing the unit directly above or below your TV set as this may cause electrical interference. Keep all magnets away from electronic equipment.

5 USING ACCESSORIES

Use only accessories recommended by the manufacturer to avoid risk of fire, shock, or other hazards.

6 CLEANING THE UNIT

Unplug the unit. Then, use a clean, dry, chemically untreated cloth to gently remove dust or debris. **DO NOT USE** cleaning fluids, aerosols, or forced air that could over-spray, or seep into the unit and cause electrical shock. Any substance such as wax, adhesive tape, etc. may mar the cabinet surface. Exposure to greasy, humid, or dusty areas may adversely affect internal parts.

SERVICE

1 DO NOT SERVICE THIS PRODUCT YOURSELF

If, after carefully following the detailed operating instructions, this Video product does not operate properly, do not attempt to open or remove covers, or make any adjustments not described in the manual. Unplug the unit and contact a qualified service technician.

2 IF REPLACEMENT PARTS ARE REQUIRED

Make sure the service technician uses only parts specified by the manufacturer, or those having the same safety characteristics as the original parts. The use of unauthorized substitutes may result in fire, electric shock, or other hazards.

3 HAVE THE SERVICE TECHNICIAN PERFORM A SAFETY CHECK

After any service or repairs to the unit, request the service technician to conduct a thorough safety check as described in the manufacturer's service literature to insure that the video unit is in safe operating condition.

Unpacking Your VCR • Product Features

Unpacking Your VCR

The accessories below are provided to help you use or set up your VCR.

Accessories

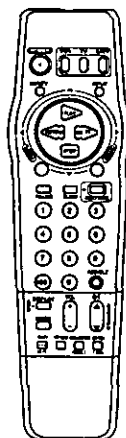

Remote Control

VSQS1488 (PV-7200/PV-7400)
VSQS1480 (PV-7450)

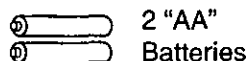

2 "AA"
Batteries

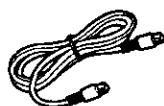

RF Coaxial
Cable
VJAS0183

Model PV-7450 remote is shown here.

To order accessories, call toll free 1-800-332-5368

Loading the Batteries

1 Push in and up on the latch with your thumb nail and lift off the lid.

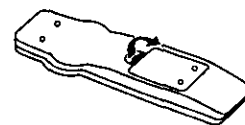

2 Install two batteries as indicated inside the Battery Compartment.

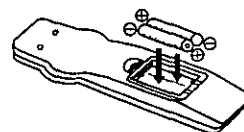

3 Fit the lid's hinge piece into the indent on the case, and snap the lid into place.

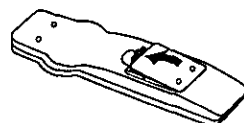

Battery replacement caution

- Do not mix old and new batteries.
- Do not mix alkaline with manganese batteries.

Product Features

| | |
|---|----------------|
| All Channel Auto Set/ 181-CH TV/CATV Tuner | 12 |
| Auto Daylight Saving Time | 5 |
| Auto Features for a Quality Picture | 15 |
| Auto Operation Functions (Auto Playback, Rewind, Tape Eject, Power off) | 20 |
| Auto Repeat Function | 20 |
| Digital Auto Picture (For Models PV-7400 and PV-7450 only) | 15 |
| Easy-to-Read English/Spanish/French On-Screen Displays | 12, 13, 18, 19 |
| MTS Broadcast System (For Model PV-7450 only) (Multi-channel Television Sound-Stereo, SAP, Mono) .. | 22 |
| Multi Brand TV/Cable Box Remote Control | 24, 25 |
| One Minute Skip | 20 |
| One Month, 8 Program Timer Recording | 18, 19 |
| One Touch Recording (OTR) | 16 |
| Program Director Remote Control | 18, 19 |
| Special Effects Playback | 15 |
| Timer Recording Using VCR Buttons | 19 |
| VHS Hi-Fi Stereo System (For Model PV-7450 only) | 23 |
| VHS Index Search System (Direct Access Search, Index Scan Search) | 21 |
| Zero Search | 20 |

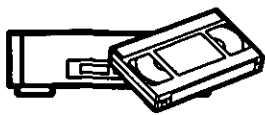

VCR and Cassette Information

Erase Protection (Record Tab)

Cassettes have a record tab to ensure that recordings are not accidentally erased.

To prevent accidental erasure, break off the tab with a screwdriver.



To record again, cover the hole with cellophane tape.



Maximum Record/Playback Time

Only use tapes with the **VHS** mark in this unit.

| Tape Speed Setting | Type of Video Cassette | | |
|-----------------------|------------------------|---------|--------------------|
| | T60 | T120 | T160 |
| SP (Standard Play) | 1 Hour | 2 Hours | 2 Hours 40 Minutes |
| LP (Long Play) | 2 Hours | 4 Hours | 5 Hours 20 Minutes |
| SLP (Super Long Play) | 3 Hours | 6 Hours | 8 Hours |

D.S.T. (Daylight Saving Time)

Spring (First Sunday in April)

When the VCR is set to DST:ON, it automatically adds one hour and adjusts the clock.

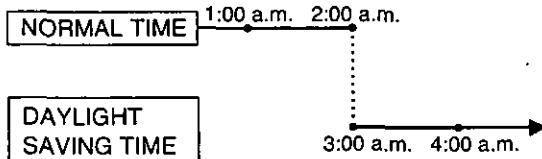

Autumn (Last Sunday in October)

When the VCR is set to DST:ON, it automatically turns back one hour and adjusts the clock.

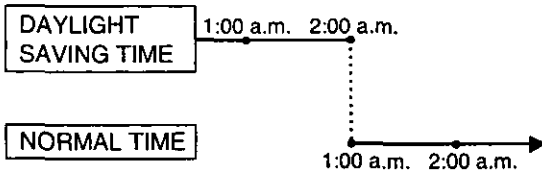

Head Cleaning

Your VCR will not normally require head cleaning, however the heads may become clogged when playing an old or damaged tape.

Head Clog Sensor

If head cleaning becomes necessary, the VCR will display the screen at right while playing back a recorded signal.

To exit this screen, push PLAY on the remote control or VCR.

- Use "dry" type head cleaning cassette* only.
- Be sure to follow the cleaning tape instructions carefully. Excessive use of a cleaning cassette can shorten head life.
- If using a head cleaning cassette does not solve the problem, contact your nearest Factory Service Center or authorized Service Center. (See page 28.)

VIDEO HEADS MAY
NEED CLEANING
PLEASE INSERT HEAD
CLEANING CASSETTE
OR REFER TO MANUAL

END:PLAY KEY

* Cleaning cassette part No. NV-TCL30PT is recommended.

Reset all VCR Memory Functions

Use when moving the VCR to a new location, or if a mistake was made in the One Time VCR Setup section.

- Make sure a tape is not inserted in the VCR.

- 1) Turn VCR Power on.
- 2) Push and hold both PLAY and CH ▲ buttons on the VCR for more than 5 seconds.
 - The power will shut off.
- 3) Perform the One Time VCR Setup section on page 12.

Specifications

- Power Source:** 120V AC, 60 Hz
- Power Consumption:** **Power On**
Approx. 18 watts (PV-7200/PV-7400)
Approx. 23 watts (PV-7450)
Power Off
Approx. 6 watts (PV-7200/PV-7400)
Approx. 7 watts (PV-7450)
- Video Signal:** EIA Standard NTSC color
- Video Recording System:** 2 rotary heads helical scanning system (PV-7200)
4 rotary heads helical scanning system (PV-7400/PV-7450)
- Audio Track:** 1 track (Normal)
2 channels (Hi-Fi Audio Sound) (PV-7450)
- Tuner**
- Broadcast Channels:** VHF 2~13, UHF 14~69
- CATV Channels:** Midband A through I (14~22)
Superband J through W (23~36)
Hyperband AA~EEE (37~64)
Lowband A-5~A-1 (95~99)
Special CATV channel 5A (01)
Ultraband 65~94, 100~125
- Operating Temperature:** 41°F~104°F (5°C~40°C)
- Operating Humidity:** 10%~75%
- Weight:** 7.5 lbs. (3.4 kg)
- Dimensions:** 14-15/16" (W) x 3-2/3" (H) x 11-13/16" (D)
380 (W) x 93 (H) x 300 (D) mm

Note: Designs and specifications are subject to change without notice.



Basic Connection

ANTENNA

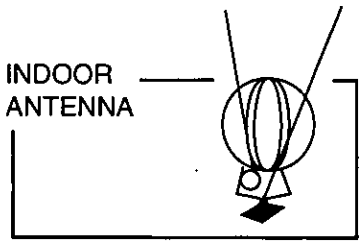

or

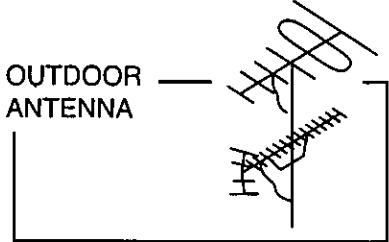

or

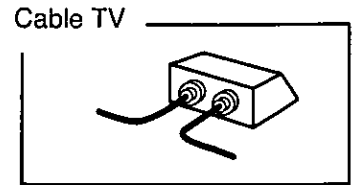

Disconnect the antenna or cable from your TV and connect it to the VCR (IN FROM ANT.)

VCR

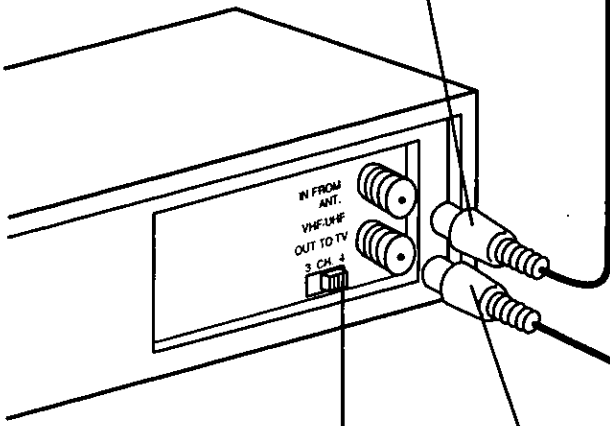

Set the Output Channel of your VCR to channel 3 or 4 (whichever is not being transmitted on by a Local TV broadcast).

Antenna Cable

TV

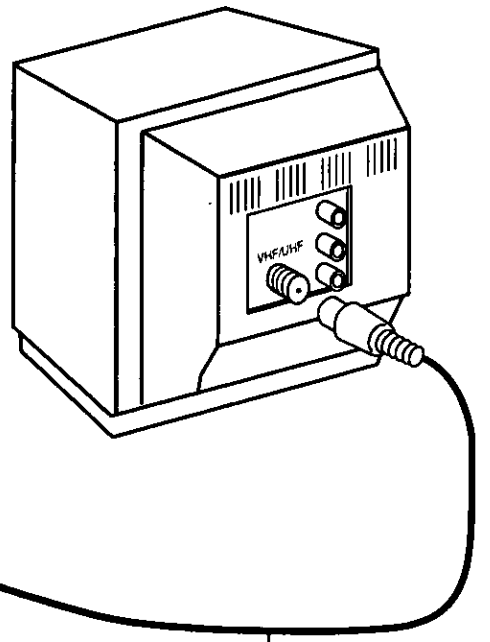

RF Coaxial Cable (VCR-TV Connection Cable) (supplied)

Connect the VCR to your TV with the RF Coaxial Cable (OUT TO TV).

WARNING

When using "Nut type" RF coaxial cables, tighten with fingers only. Overtightening may damage terminals.

Between Antenna and VCR

Case 1: Twin Lead Cable Only

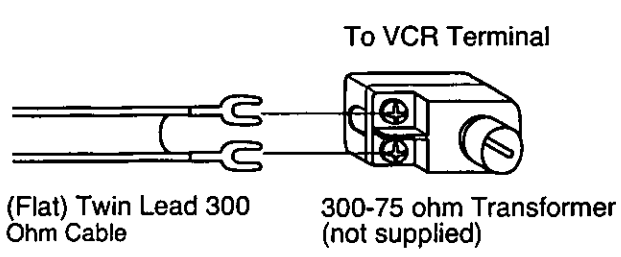

Case 2: Twin Lead & Coaxial Cables

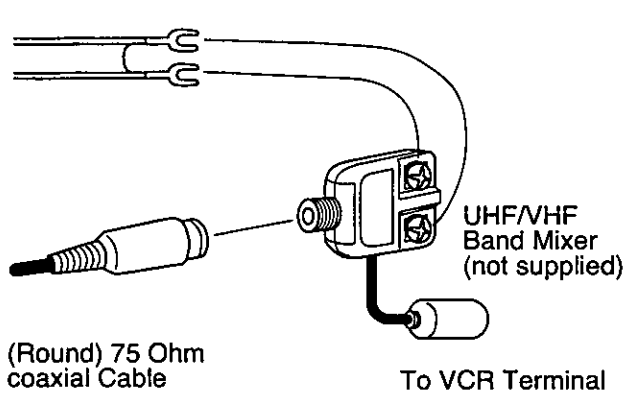

Case 3: Two Twin Lead Cables

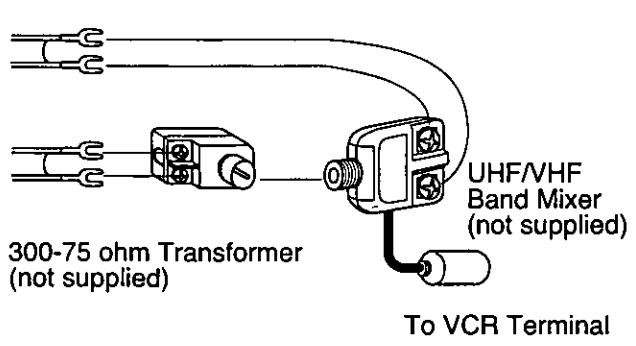

• If your TV has both post and plug-type VHF terminals, the post connection is recommended to minimize signal loss.

Between VCR and TV

Case 1: Screw & Plug Type Terminal

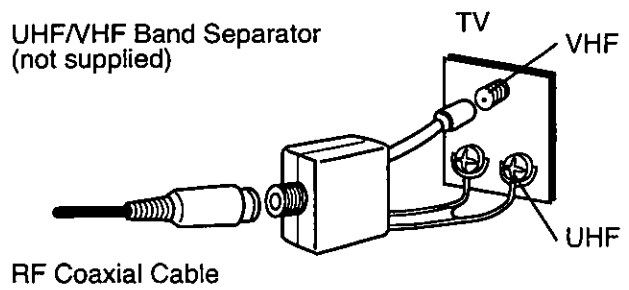

Case 2: Screw Type Terminal

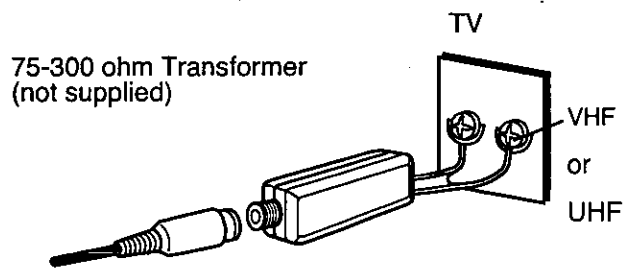

Case 3: Double Screw Type Terminal

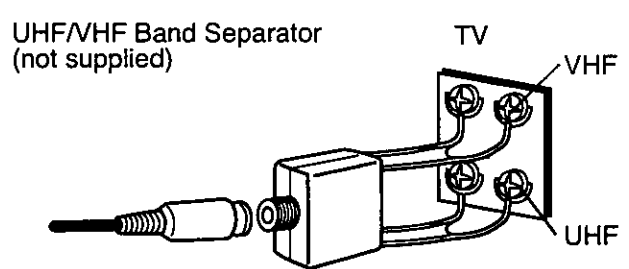

Case 4: Complex TV Terminal

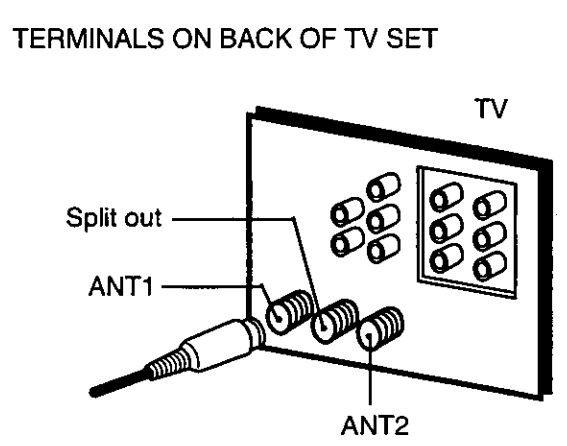

• Connect to one of the ANT terminals and select the same antenna number on the TV.



Additional Connections

CATV(Cable) Connections

All connections on this page are made with 75 Ohm coaxial cables.

Without a Converter/Descrambler Box

You can:

- 1) Use your VCR Remote Control to select channels.
- 2) Program one or more unscrambled channels for unattended recording.

You cannot:

record or view scrambled channels with this connection.

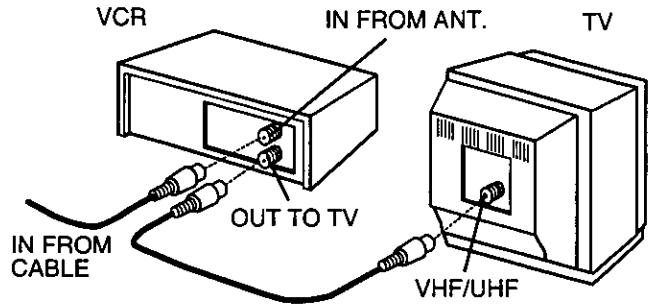

With a (CABLE to VCR) Converter/Descrambler Box

You can:

- 1) Record and view any channel including scrambled channels; channel selection must be made at the Cable TV Converter Box.
- 2) Program one channel for unattended recording.

You cannot:

select channels from VCR or TV.

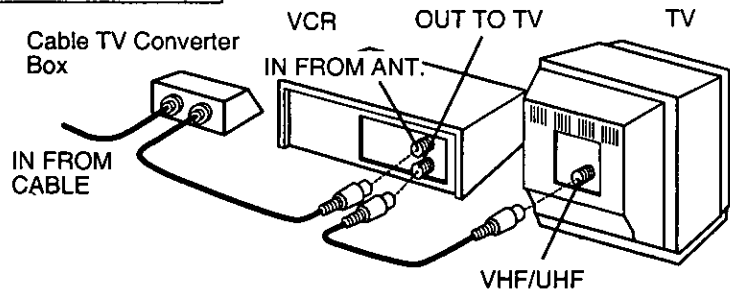

With a (VCR to TV) Converter/Descrambler Box

You can:

- 1) Use your VCR Remote Control to select channels.
- 2) Program unattended recordings of more than one unscrambled channel.

You cannot:

record scrambled channels with this connection.

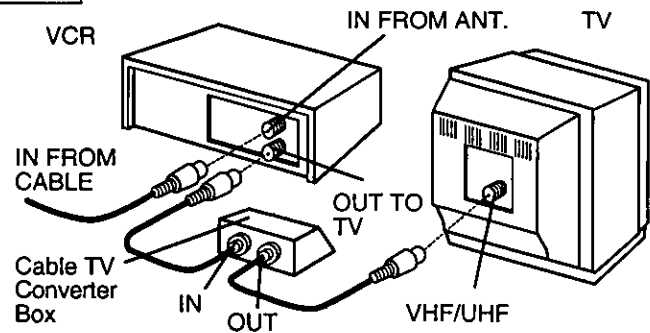

With Two Converter/Descrambler Boxes

If you want to record and view a combination of scrambled and unscrambled channels, you will need additional equipment. This connection requires two converter boxes, an A/B switch, and a 2-way splitter as shown here.

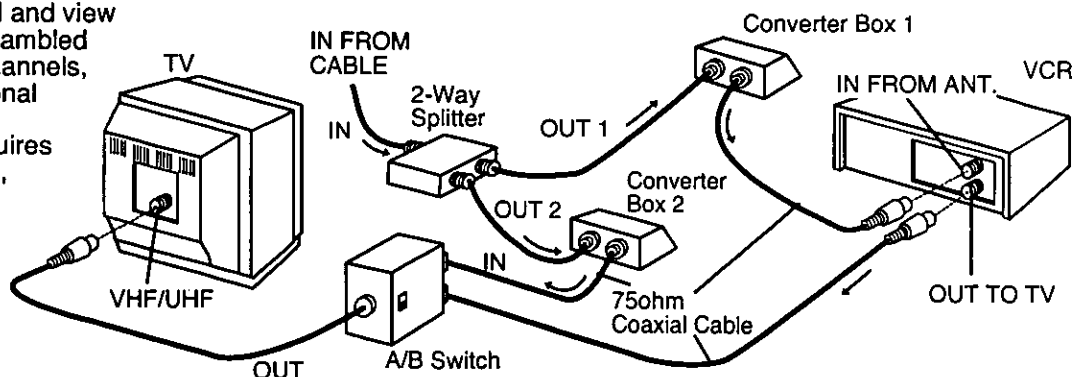

Audio/Video Connections

If your TV has AUDIO IN and VIDEO IN terminals, you can connect your VCR to them to receive a higher quality picture and sound. If your TV is not stereo, you can connect a stereo amplifier to enjoy stereo sound.

Audio/Video Connections

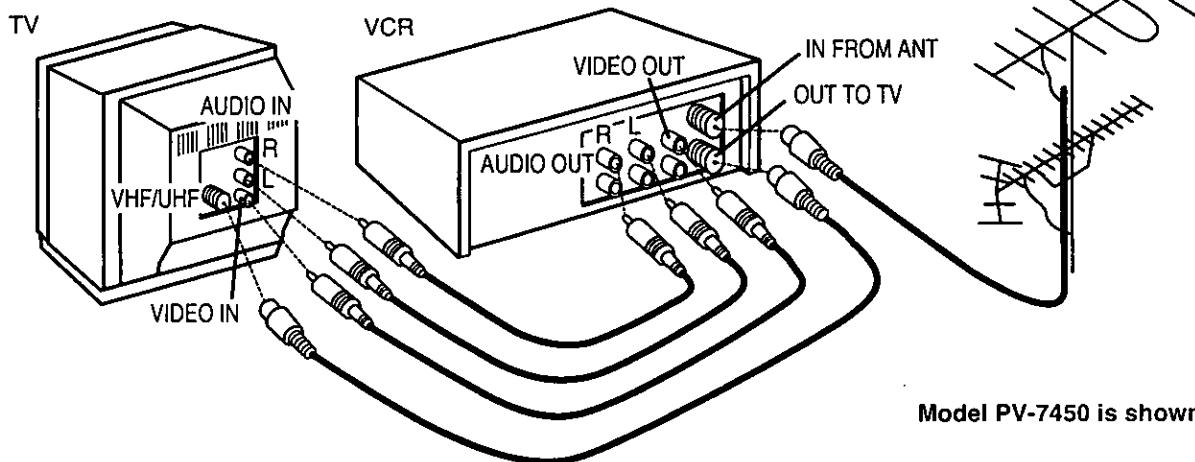

Model PV-7450 is shown here.

- 1 Connect the VIDEO OUT terminal on the VCR to the VIDEO IN terminal of your TV.
- 2 Connect the "L" and "R" AUDIO OUT terminals on the VCR to the "L" and "R" AUDIO IN terminals of your TV.
- 3 Set the VIDEO/TV selector of your TV (Monitor/Receiver) to "VIDEO."

NOTE: To use your TV as a VCR monitor, set the VIDEO/TV selector on the TV (Monitor/Receiver) to "VIDEO."
For model PV-7450, use the L Audio In jack for proper sound reproduction when connecting to a monaural TV.

Stereo Amplifier Connections

When you connect your VCR to a Stereo Component System, you can view the picture from the VCR while enjoying stereo from your audio system.

Connect the "L" and "R" AUDIO OUT terminals on the VCR to the "L" and "R" AUDIO IN terminals of your stereo.

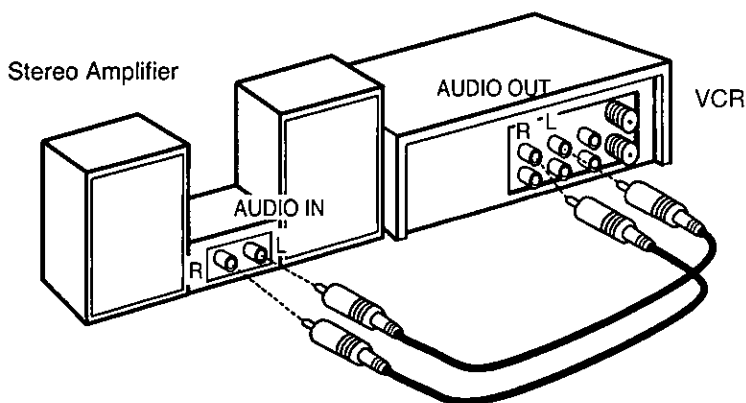

Note to CATV system installer:

This reminder is provided to call the CATV system installer's attention to Article 820-40 of the NEC in USA (and to the Canadian Electrical Code in Canada) that provides guidelines for proper grounding and, in particular, specifies that the cable ground shall be connected to the grounding system of the building, as close to the point of cable entry as practical.

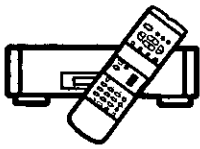

Location of Controls

Remote Control Buttons

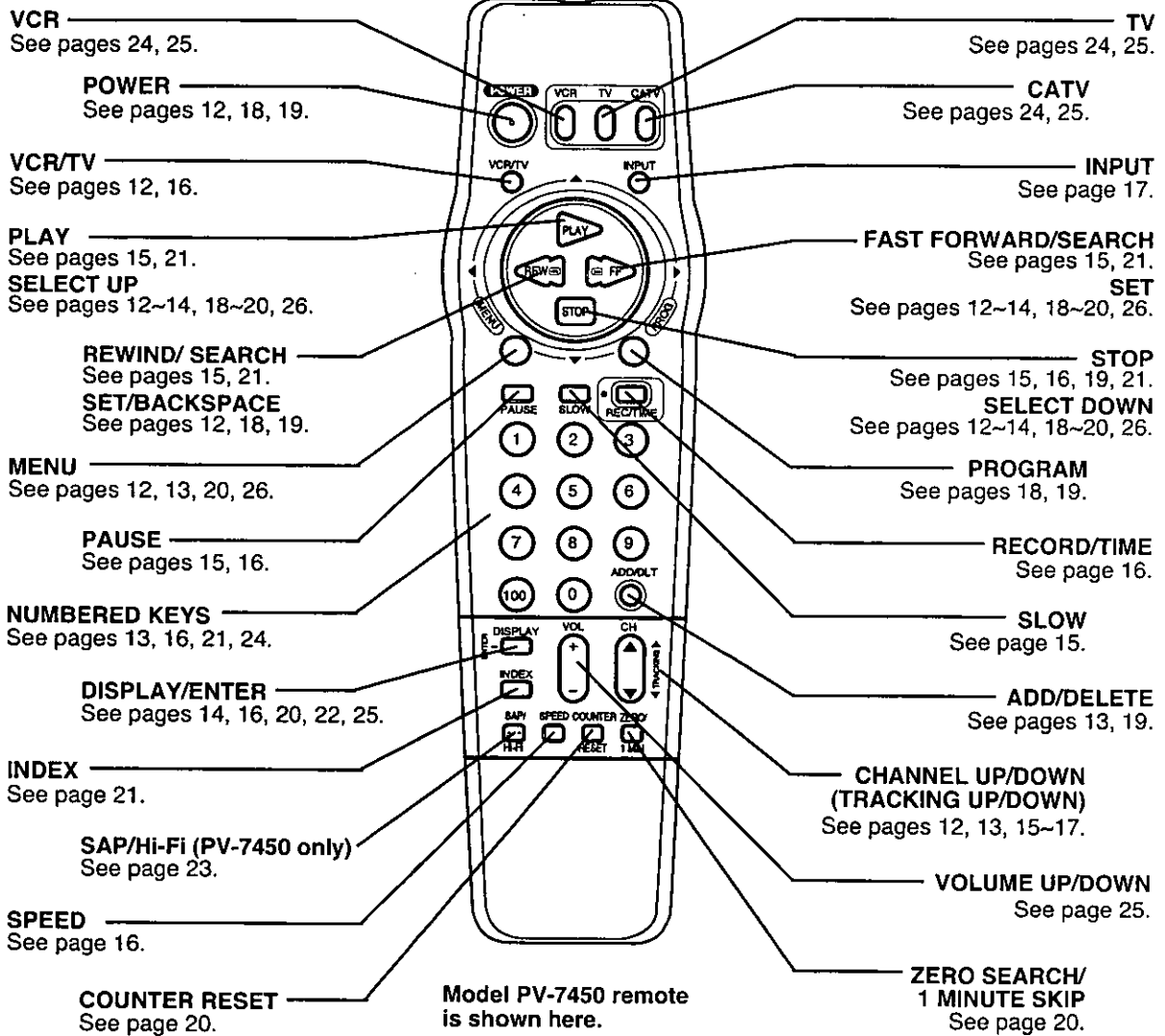

Front View of the VCR

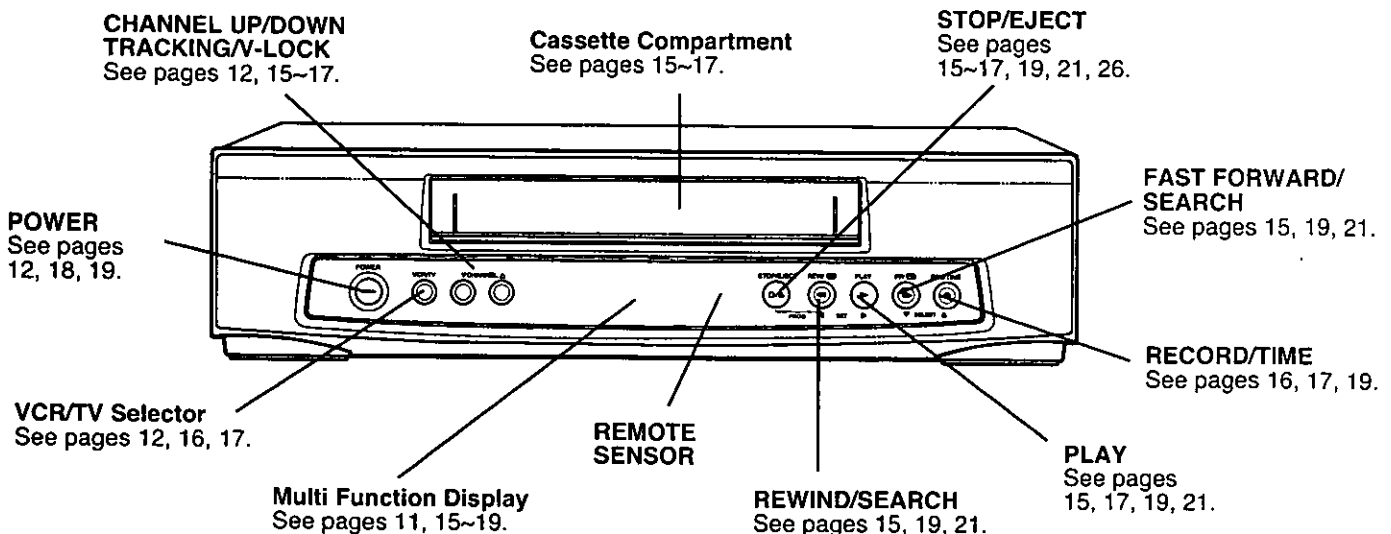

Multi Function Display

VCR Indicator
Lights when the VCR/TV selector is set to VCR.

Hi-Fi Indicator
Lights when Hi-Fi audio is monitored or played back.
(For Model PV-7450 only)

Power Indicator
Lights when power is on.

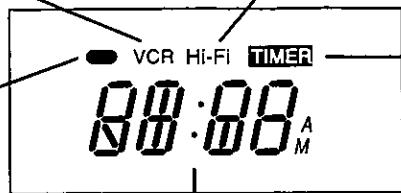

Timer Indicator
Lights when the VCR is set for a Timer Recording, or when a length is set for a normal recording. Flashes when a Timer Recording is set, but a tape has not been inserted into the VCR.

Clock/Status/Channel/Speed Display
Displays the current time.
Briefly displays VCR status when a function button is pushed.
Briefly displays the channel number, or "L" when a channel or line input is selected.
Briefly displays the recording speed when SPEED is pushed.

Rear View of the VCR

• For Models PV-7200/PV-7400

AC Power Plug
While plugged into an AC outlet, the VCR consumes 6W of electric power in OFF condition.

Audio Output Connector
See pages 9, 17.

Video Output Connector
See pages 9, 17.

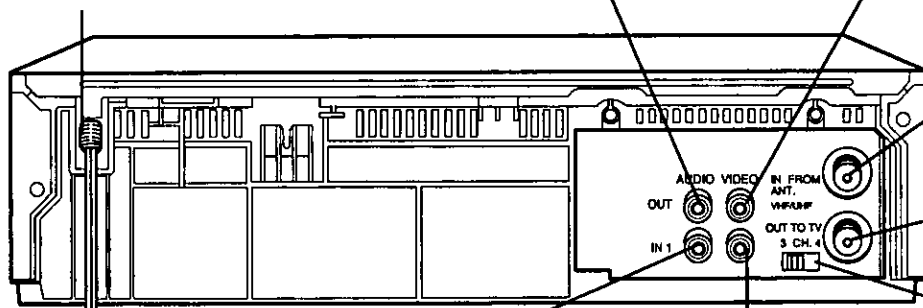

VHF/UHF Antenna Input Terminal
See pages 6~9.

VHF/UHF Antenna Output Terminal
See pages 6~9, 17.

Audio Input Connector
See page 17.

Video Input Connector
See page 17.

Channel 3/4 Switch
See pages 6, 12.

• For Model PV-7450

AC Power Plug
While plugged into an AC outlet, the VCR consumes 7W of electric power in OFF condition.

Audio Output Connector (L/R)
See pages 9, 17, 22.

Video Output Connector
See pages 9, 17, 22.

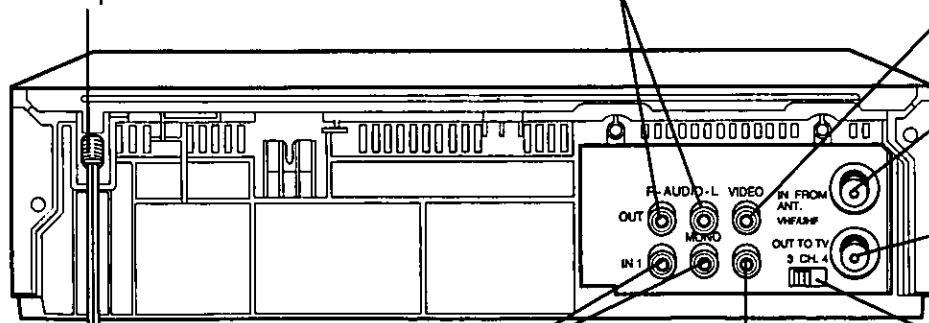

VHF/UHF Antenna Input Terminal
See pages 6~9, 22.

VHF/UHF Antenna Output Terminal
See pages 6~9, 17, 22.

Audio Input Connector (L/R)
See page 17.

Video Input Connector
See page 17.

Channel 3/4 Switch
See pages 6, 12.

One Time VCR Setup

When the VCR power is first turned on, the language select and channel auto set screens appear automatically followed by a prompt to set the clock.

Check list before you begin.

- All TV and VCR connections are made. (See pages 6~9.)

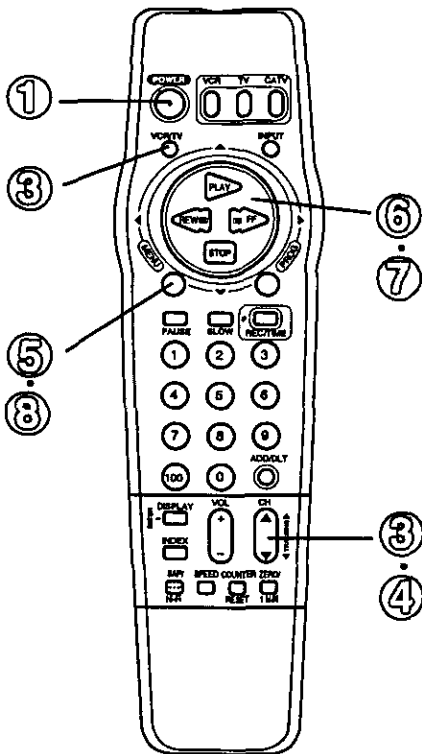
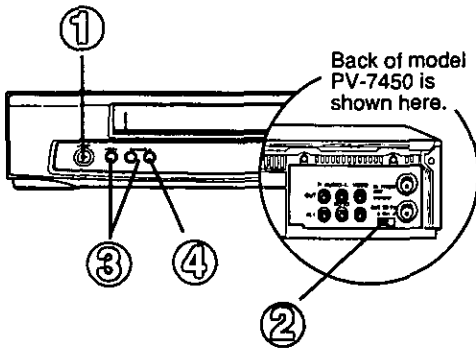

Model PV-7450 remote is shown here.

Using ▲▼◀▶ keys

Whenever a menu or program screen is displayed, the PLAY, STOP, REWIND, and FF buttons on the remote control function as ▲▼◀▶ only. For play, stop, rewind, and fast forward functions, use the buttons on the VCR.



To Set the Language, Channels, and Clock

- Turn TV and VCR on.

- Tune TV to VCR output channel (the same one you set on the back of the VCR; CH3 or CH4).

- Push CH ▲ for English on-screen displays.
 or
 Push CH ▼ for Spanish on-screen displays.
 or
 Push VCR/TV for French on-screen displays.

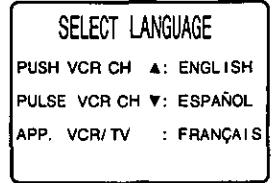

- If wrong language is set, see the "Reset all VCR Memory Functions" section on page 5.

- You can also set the language using the buttons on the VCR.
- The VCR should be connected to an antenna or cable box (page 6~9).
- If using a cable box, leave it on for auto channel set.

- Push CH ▲ to start Channel Auto Set.
 • The following message appears.
 "PLEASE SET CLOCK BY PUSHING MENU KEY"

- Push MENU to display the SET CLOCK screen.
 • Make each entry within 5 minutes, or the VCR exits the Set Clock screen.

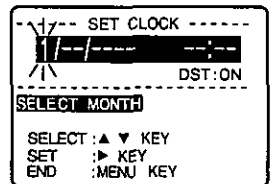

- Push ▲▼ to select the MONTH, and then push ▶ to enter.

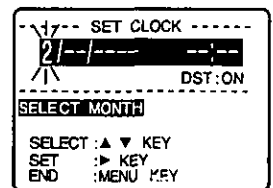

- Push ▲▼ and ◀▶ to select and set remaining items at right.
 • Pushing ◀ will move back to an item for correction.

- Remaining items to be set:
- Date
 - Year
 - Time
 - D.S.T. (Daylight Saving Time see page 5)

- Push MENU twice to start the clock and exit this mode.

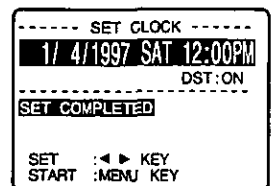

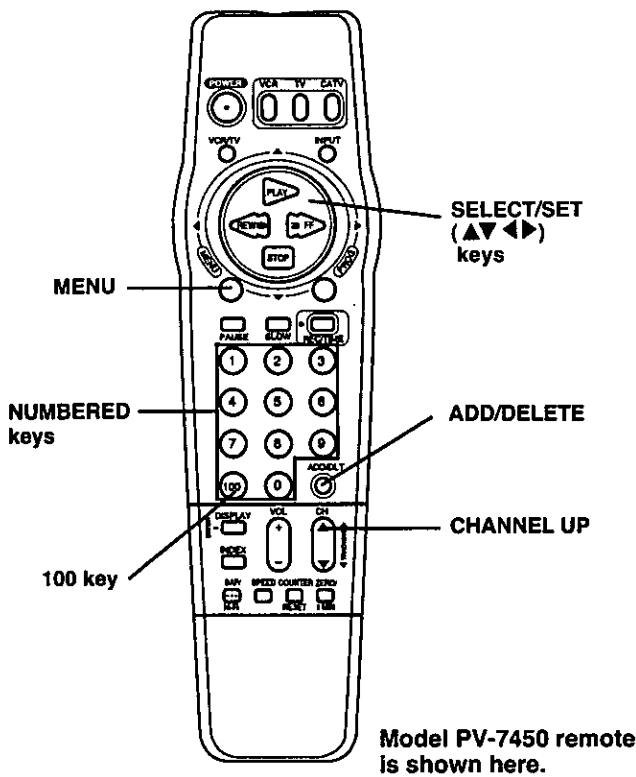

To Replace Channels in Memory

In case you have cable installed, etc.

- 1 Push MENU to display the menu.
- 2 Push ▲▼ to select "SET UP CHANNEL," and then push ► to display the "SET UP CHANNEL" screen.
- 3 Push ▲▼ to select "ANTENNA SYSTEM," and then push ► to set your antenna system (TV or CATV).
- 4 Push ▲▼ to select and ► to set "AUTO SET."
 - If you use a cable box, it must be left on for auto channel set.
- 5 Push CH ▲ to start Channel Auto Set.
 - To exit this mode, push MENU twice.

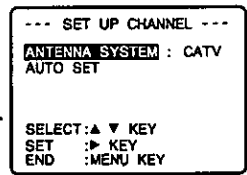
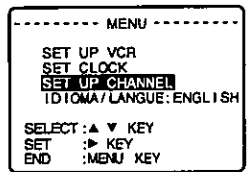

To Change On Screen Display Language

- 1 Push MENU to display the menu.
- 2 Push ▲▼ to select the language.
 - English: LANGUAGE
 - Spanish: IDIOMA
 - French: LANGUE
- 3 Push ► repeatedly to change the language.

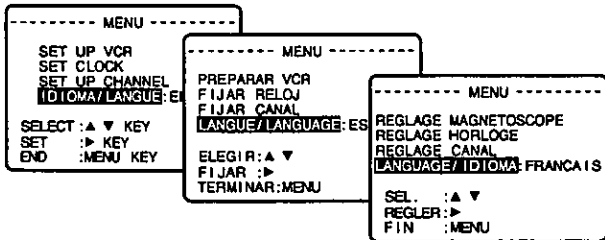
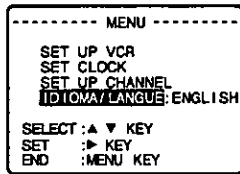

- 4 Push MENU to exit this mode.

When Using the 100 key

When selecting CATV channels 100 to 125 with the NUMBERED keys, first push the 100 key and then enter the remaining two digits. For example, to select channel 125: Push NUMBERED keys 100, then 2, then 5.

To Set or Reset the Clock

In case the clock is wrong, or a power failure occurred.

- 1 Push MENU to display the menu.
- 2 Push ▲▼ to select "SET CLOCK," and then push ► to display the "SET CLOCK" screen.
- 3 Push ▲▼ and ◀▶ to select and set the time and date.
- 4 Push MENU twice to start the clock and exit this mode.

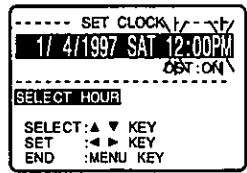
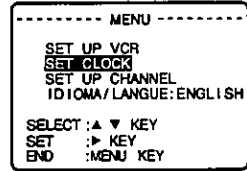

To Add or Delete a Channel

- 1 Select a channel using the NUMBERED keys to add or the CH ▲/▼ to delete.
- 2 Push ADD/DLT to add or delete the channel.
 - To select a channel once it's deleted, use the NUMBERED keys on the remote control. Deleted channels will flash in the Multi Function Display on the VCR when selected.

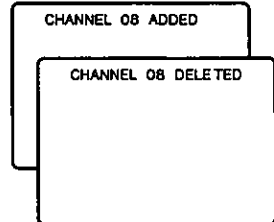

- This VCR will accurately maintain its calendar up to Dec. 31, 2015, 11:59PM.
- Normal TV or Cable channels are automatically selected and placed in memory depending on how your VCR is hooked up.

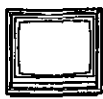

On-Screen Displays (OSD)

Function & Channel Display

When a function button is pushed, e.g. PLAY, or you change channels, a 4 second display appears first in large and then small characters.

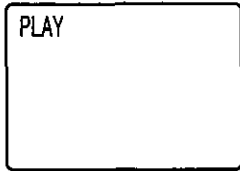

Menu Screen

1 Push MENU to display the menu.

2 Push ▲▼ and ► to make your selection.

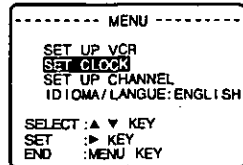

• To get the most from each feature, please read the Operating Manual before attempting any operation.

VCR Status & Clock Display



Push DISPLAY to display or remove the overlay shown below.

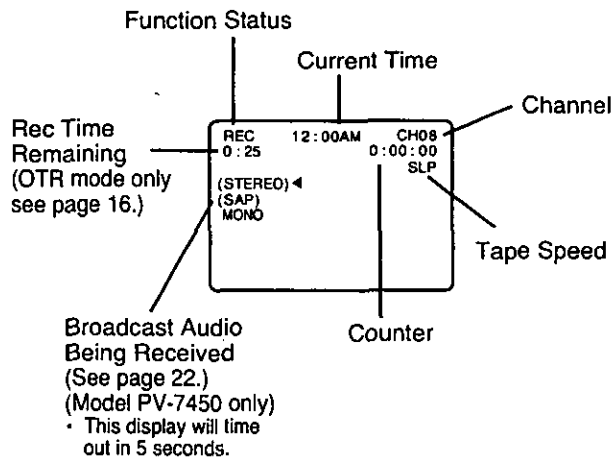

Blank Tape/ No Video Signal Indication

When a blank section of tape comes up in Play mode, or the selected channel has no broadcast signal, the TV screen will turn solid blue.

Warning and Instruction Displays

These displays will alert you of a missed operation or provide further instructions.

If no active channels are found for CHANNEL MEMORY... (See page 12.)

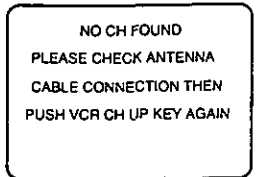

If you attempt to set or review a Timer Recording and the Clock is not set... (See page 18.)

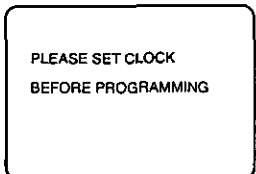

After a Timer Program has been set... (See page 18.)

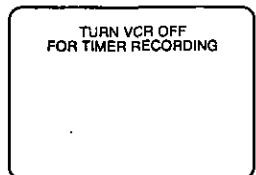

If you push REC on the remote control or VCR, and a cassette is inserted with no record tab... (See page 16.)

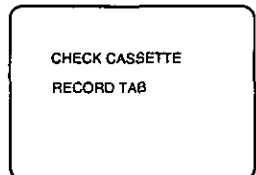

If you push PLAY, FF, REW, or REC on the remote control or VCR without a cassette inserted... (See pages 15, 16.)

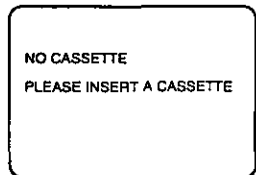

If you push POWER or STOP during a Timer Recording... (visible in VCR mode only) (See page 19.)

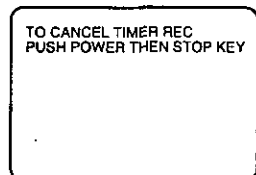

If head cleaning becomes necessary while playing back a tape... (See page 5.)

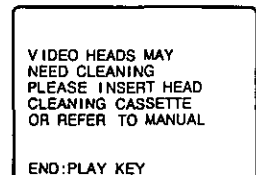

If you push a function button other than STOP/EJECT or POWER while the VCR is in VCR Lock mode... (See page 26.)

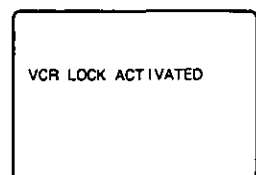



Playback a Tape

Check list before you begin.

- All connections are made. (See pages 6~9.)
- TV and VCR are plugged in.
- TV is turned on and set to the VCR channel (CH 3 or 4).

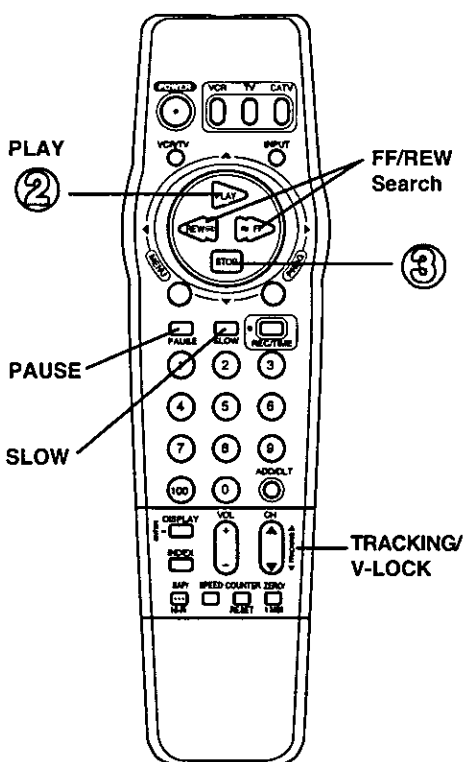
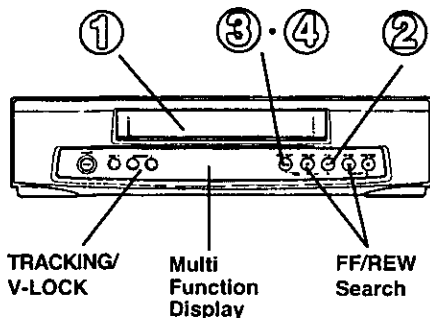

Model PV-7450 remote is shown here.

Caution:

Please inspect your cassette tapes for any loose or peeling labels as they may become jammed in your unit.

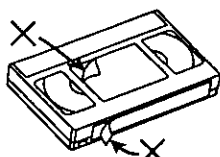

1

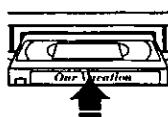

Insert a cassette.

- VCR power comes on automatically.

This indicator lights in the Multi Function Display.

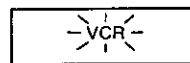

2



Push **PLAY** on the remote or VCR to start playback.

- Playback begins automatically if cassette has no record tab.

3



Push **STOP** on the remote or VCR to stop playback.

4



Push **STOP/EJECT** on the VCR to eject the cassette.

- You may eject a cassette with power on or off.

To Find a Particular Scene During Playback

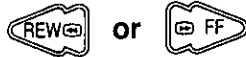

Push **REW** or **FF** during playback to search for a scene.

- Search speed for SP mode tapes is 9 times (Models PV-7400 and PV-7450 only) and SLP mode tapes 27 times the normal speed.
- Some noise bars will appear during search.

Special Effects During Playback

These features work best in SLP mode. (SP or SLP mode for models PV-7400 and PV-7450.) The sound will be muted.

Slow Motion Playback

Push **SLOW** to start slow motion playback. Push **PLAY** or **SLOW** to release.

Still (Freeze) Frame Picture

Push **PAUSE** to freeze and release the picture.

- To reduce picture noise, first push **SLOW**. Then, use **CH** (TRACKING) $\blacktriangle/\blacktriangledown$ to clear up the picture, then push **PAUSE**.

Frame by Frame Advance

In Still mode, hold down **SLOW** to advance the still picture one frame at a time. Push **PAUSE** to release.

Features for a Quality Picture

Digital Auto Picture (For Models PV-7400 and PV-7450 only)

This feature automatically controls the video output signal for less noise depending on the tape condition.

Digital Auto Tracking

This feature continuously analyzes the signal and adjusts for optimum picture quality.

Manual Tracking Control (to reduce picture noise)

Use during Playback and Slow Motion mode to reduce picture noise. Push **CH** (TRACKING) $\blacktriangle/\blacktriangledown$ during playback until the picture clears up. To return to Auto Tracking mode, push **POWER** off and then on again.

V-Lock Control (to reduce picture jitter)

(For Models PV-7400 and PV-7450 only)

In Still mode, **CH** (TRACKING) $\blacktriangle/\blacktriangledown$ operate as a V-Lock control. Push $\blacktriangle/\blacktriangledown$ until the picture is stabilized.



- After the VCR is in Still or Slow mode for 3 minutes, it will switch to the Stop mode automatically to protect the tape and the video head.

Record On a Tape

✓ Check list before you begin.

- All connections are made. (See pages 6~9.)
- VCR is Plugged in.
- TV is turned on and set to the VCR channel (CH3 or CH4).

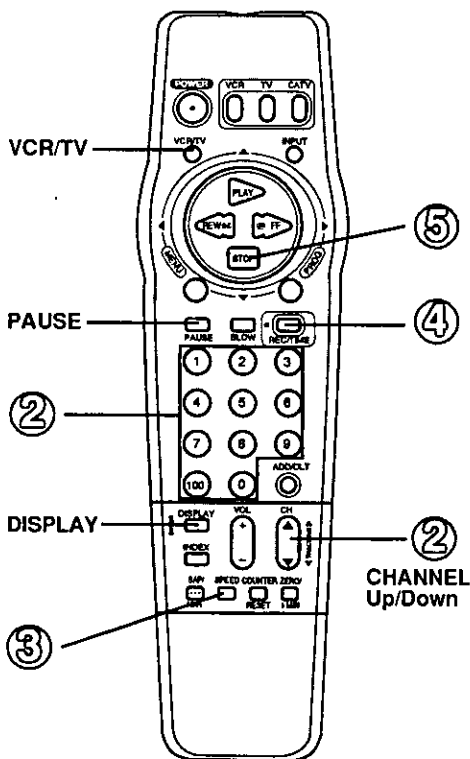
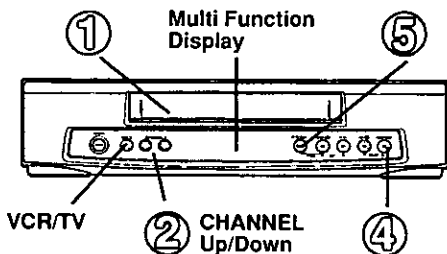

Model PV-7450 remote is shown here.

1 Insert a cassette with record tab.

- VCR power comes on automatically.

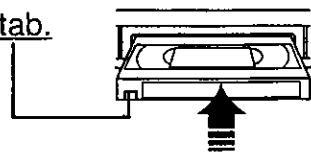

2 Push CH ▲/▼ or NUMBERED keys to select a channel.

- Or, push CHANNEL ▲/▼ on the VCR.
- Holding down CH ▲/▼ will increase the channel search speed.
- To record from an outside source, push CH ▲/▼ or INPUT to select "LINE" (see page 17).

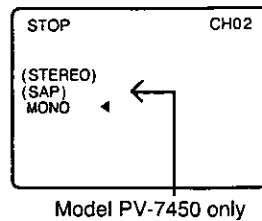

Model PV-7450 only

3 Push SPEED to change the recording speed.

- SP = Standard Play
- LP = Long Play
- SLP = Super Long Play (See page 5.)

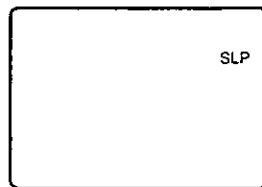

4 Push REC/TIME on the remote control or VCR to start recording.

- To edit out unwanted portions, push PAUSE to pause the recording in progress. To release, push PAUSE again. (After the VCR has been in Pause mode for 5 minutes, it will stop automatically to protect the tape and video head.)

One Touch Timer Recording (OTR)

The VCR starts recording and turns itself off at a preset time. In step 4, push REC/TIME repeatedly to set the length of the recording. Each push will change the stop time as shown.

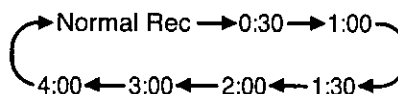

- "TIMER" lights in the Multi Function Display.
- The remaining recording time can be displayed by pushing DISPLAY in OTR mode.

5 Push STOP to stop recording.

- Or, push STOP/EJECT on the VCR.

Record One Program While Watching Another

- 1 Push VCR/TV while recording is in progress to turn off the VCR indicator in the Multi Function Display.
- 2 Use the TV channel controls to select a program. The VCR will continue to record your program while you watch any channel you choose.
 - To switch back and forth between the recording and viewing channel, push VCR/TV.

Selecting Channels at the VCR

- 1 Turn your TV and VCR on.
 - VCR Indicator lights on the Multi Function Display. If indicator doesn't light, push VCR/TV to turn it on.
- 2 Use CH ▲/▼ on the remote control or VCR to select channels.
 - To switch back to TV channel selection, push VCR/TV to turn VCR indicator off, or simply turn the VCR power off.



Copying Your Tapes (Dubbing)

Connections you'll need to make.

- For Models PV-7200/ PV-7400

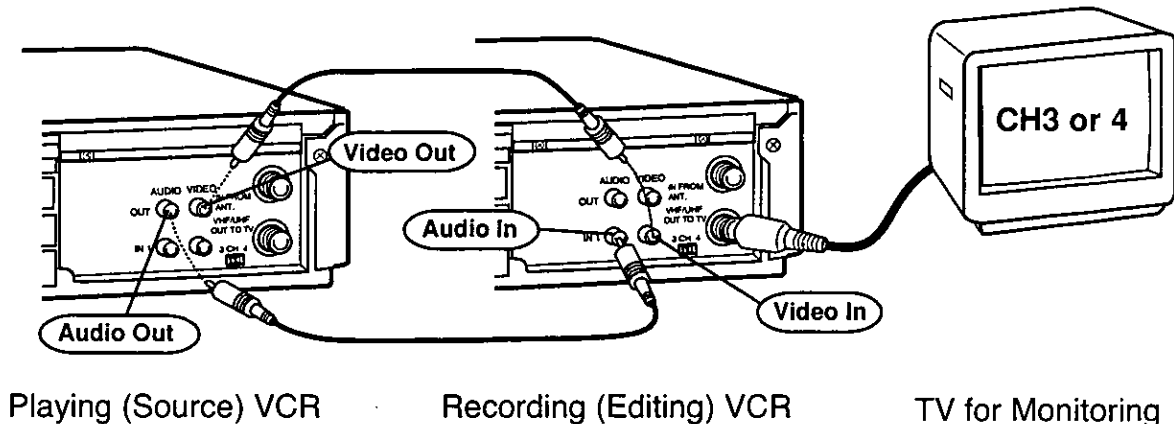

- For Model PV-7450

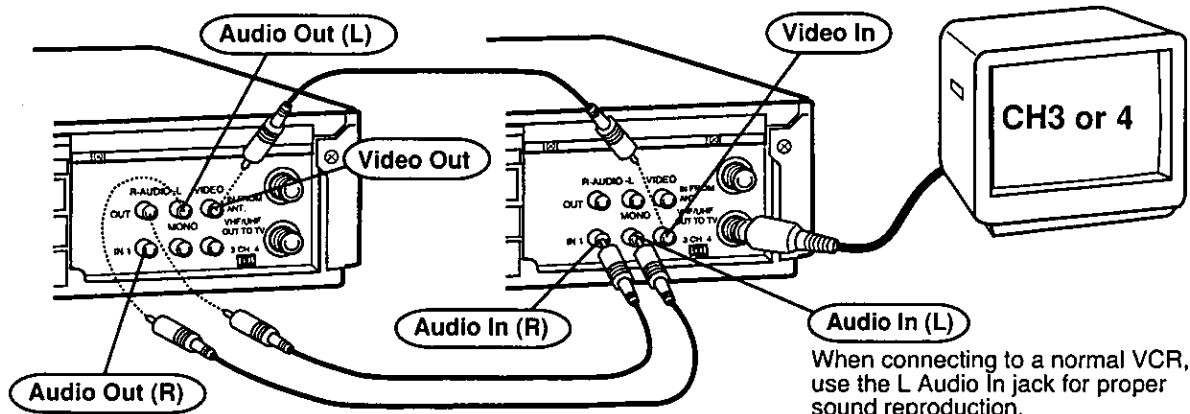

When connecting to a normal VCR, use the L Audio In jack for proper sound reproduction.

- 1 Insert a pre-recorded tape into the Playing (Source) VCR.

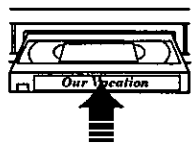

- 2 Insert a blank tape with record tab into the Recording (Editing) VCR.

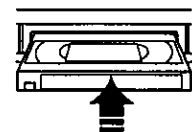

- 3 Select "LINE" Input mode on the Recording (Editing) VCR. (See "Selecting the Input Mode" at right.)

- 4 Push PLAY on the Playing VCR. Push PAUSE at desired starting point.

- 5 Push REC on the Recording VCR, and then push PAUSE immediately thereafter.

- 6 Push PAUSE on both VCRs at the same time, to begin copying.

To Edit Out Unwanted Parts, push PAUSE on the recording VCR while copying is in progress. Push PAUSE again to resume copying.

- 7 Push STOP on both VCRs to stop copying.

To Monitor Dubbing on Your TV

- 1 Turn your TV on and tune to the Recording VCR channel (CH3 or CH4).
- 2 Set the VCR/TV Selector on the Recording VCR to "VCR."

Selecting the Input Mode

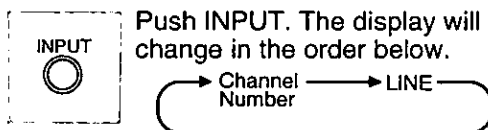

or

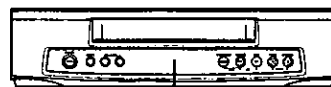
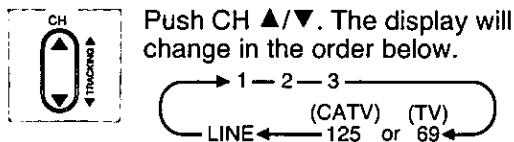

- When LINE is selected, "L" is displayed in the Multi Function Display for about 4 seconds.

Caution:

Unauthorized exchanging and/or copying of copyrighted recordings may be copyright infringement.



Timer Recording

You can set up the VCR to record a one time, daily, or weekly program while you are away or otherwise occupied. Up to 8 programs can be stored in memory.



Check list before you begin.

- All connections are made. (See pages 6~9.)
- TV and VCR are plugged in and turned on.
- VCR/TV selector is set to "VCR."
- Clock is set to correct time.
- Record tab in place. (See page 5.)

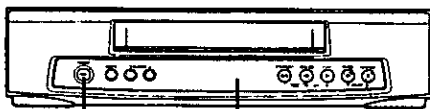

⑥ Multi Function Display

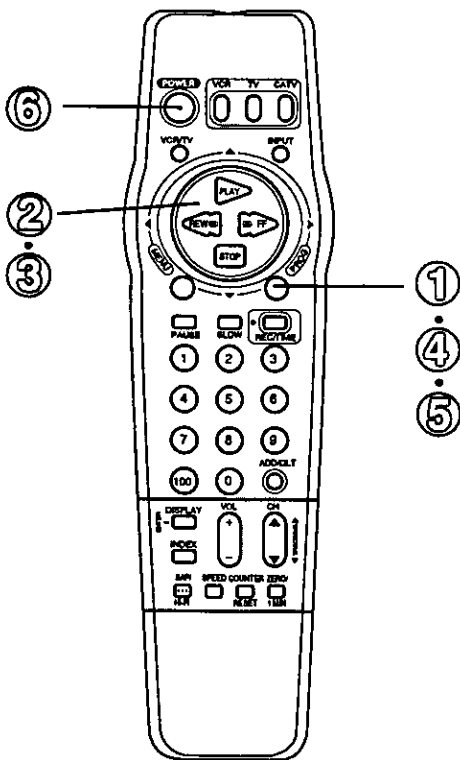

Model PV-7450 remote is shown here.

①



Push PROG to display the program screen.

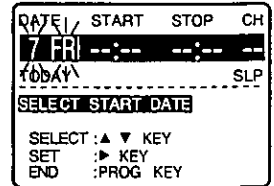

- If a program is already in memory, push ▲▼ and ► to select an unused program number.

②



Push ▲▼ and ► to select and set one of the following:

- 1~31 =One time recording
- DAILY =Same time MON~FRI
- WEEKLY =Same time once a week

Example

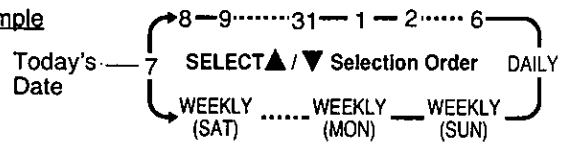

③



Push ▲▼ and ◀▶ to select and set each of the remaining items at right.

Remaining Items to be set:

- START time
- STOP time
- CH(annel) number, or LINE for outside source recording
- Speed (SP, LP, SLP)

To Make Corrections

Repeatedly push ► to move the cursor to the right, or ◀ to move to the left to the incorrect entry and make the correction.

④



Push PROG to end the program.

- This screen appears for confirmation.

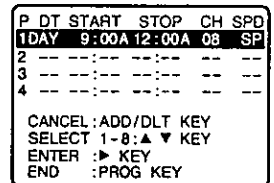

To Enter More Programs

Push ▲▼ and ► to select and set a blank program number, and then repeat steps 2 and 3.

⑤



Push PROG to exit this mode and return to the normal screen.

⑥



Push POWER off to set the timer.

- When recording programs via a cable box, make sure the cable box is left ON and tuned to the desired channel.



Multi Function Display



- A cassette with no record tab is ejected and TIMER indicator flashes when the power is turned off to set the timer.
- If the start times of two programs overlap, the lower numbered program will have priority.
- If the start time for a timer recording comes up during a normal recording or One Touch Recording (page 16), the timer recording will not be performed.
- If there is a power interruption of more than one minute, the recording will not be performed or continue.

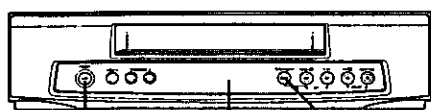

POWER Multi Function Display STOP

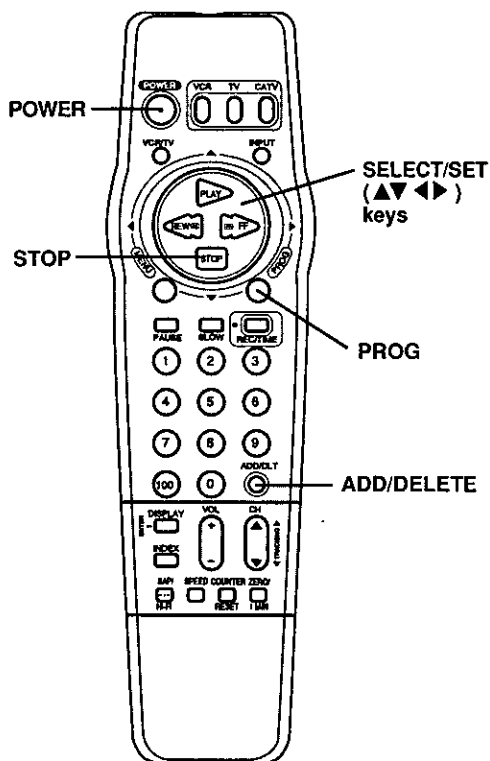

Model PV-7450 remote is shown here.

Cancel a Timer Recording: (Recording is in progress)

Push POWER and then STOP within 10 seconds to cancel the timer recording.

- The TIMER indicator goes out in the Multi Function Display.

Replace Program Contents: (Recording is not in progress)

- 1 Push PROG to display all currently set programs.
- 2 Push ▲▼ and ► to select and set a program number. (See page 18.)
- 3 Push ▲▼ and ◀► to select and set replacement timer information.
- 4 Push PROG twice to exit this mode.

| P | DT | START | STOP | CH | SPD |
|---|----|--------|--------|-----|-----|
| 1 | -- | -- | -- | -- | -- |
| 2 | 8 | 10:00P | 12:00P | 125 | SLP |
| 3 | 10 | 8:00P | 9:00P | 10 | SP |
| 4 | SU | 9:00P | 10:00P | L | SLP |

SELECT 1-8: ▲ ▼ KEY
ENTER : ► KEY
END : PROG KEY

| DATE | START | STOP | CH |
|-------|--------|--------|-----|
| 8 SAT | 10:00P | 12:00P | 125 |
| / / | | | SLP |

SELECT START DATE.
SELECT: ▲ ▼ KEY.
SET : ► KEY.
END : PROG KEY

Review or Clear Program Contents: (Recording is not in progress)

- 1 Push PROG to display all currently set programs.
- 2 Push ▲▼ to select a program number.
- 3 Push ADD/DLT to clear the program.
- 4 Push PROG to exit this mode.

| P | DT | START | STOP | CH | SPD |
|------|-------|--------|--------|-----|-----|
| 1DAY | 9:00A | 12:00A | 08 | SP | |
| 2 | 8 | 10:00P | 12:00P | 125 | SLP |
| 3 | 10 | 8:00P | 9:00P | 10 | SP |
| 4 | SU | 9:00P | 10:00P | L | SLP |

CANCEL: ADD/DLT KEY
SELECT 1-8: ▲ ▼ KEY
ENTER : ► KEY
END : PROG KEY

| P | DT | START | STOP | CH | SPD |
|---|----|--------|--------|-----|-----|
| 1 | -- | -- | -- | -- | -- |
| 2 | 8 | 10:00P | 12:00P | 125 | SLP |
| 3 | 10 | 8:00P | 9:00P | 10 | SP |
| 4 | SU | 9:00P | 10:00P | L | SLP |

SELECT 1-8: ▲ ▼ KEY
ENTER : ► KEY
END : PROG KEY

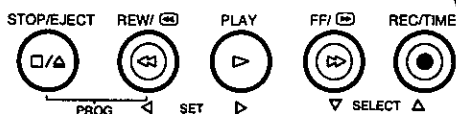
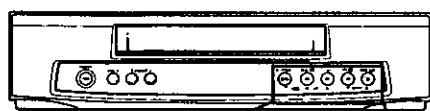

Timer Recording Using VCR Buttons

(Make sure a cassette tape is not inserted in the VCR.)

- 1 Hold down STOP/EJECT and push REW to enter the Program mode.
- 2 Push FF or REC/TIME repeatedly or hold down to make selections.
- 3 Push PLAY to set the item and move on.
 - To make corrections, repeatedly push PLAY to move the cursor to the right, or REW to move to the left to the incorrect entry and make the correction.
- 4 Push STOP/EJECT and REW together to display program contents after all items have been entered.
 - You cannot clear programs with the VCR buttons.
- 5 Hold down STOP/EJECT and push REW, (release REW first, and then release STOP/EJECT) to exit this mode.
- 6 Insert a cassette with record tab and push POWER off to set the timer.



Tape Operation

Your VCR is equipped with several time saving features as well as convenient automatic functions making tape operation easier than ever.

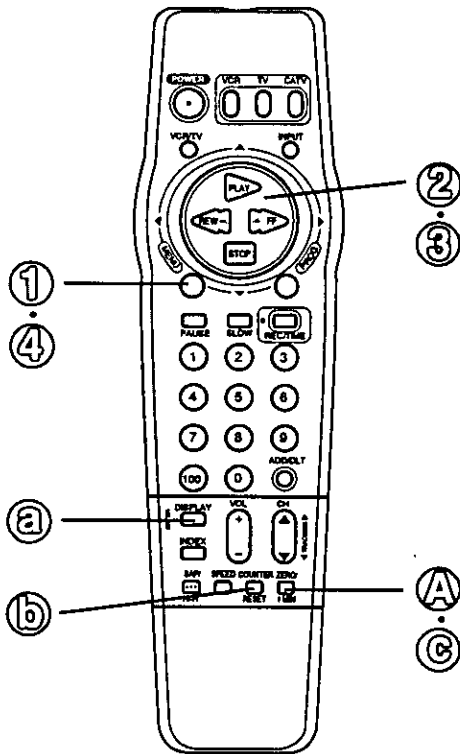

Model PV-7450 remote is shown here.

Auto Operation Functions

Auto Playback

When a tape is inserted, the power turns on (Auto). If the record tab* is removed, playback begins (Auto).

Auto Rewind

When a tape reaches its end during playback, fast forward or manual record, the VCR will rewind and go into Stop mode.

Playback Auto Eject (Repeat Play is "OFF.")

When a tape without a record tab* is played to its end, the VCR will rewind and then eject the tape.

Memory Rewind Off

When the POWER button is pushed during rewind, the VCR will turn off after rewind is complete.

* For record tab information, see page 5.

Repeat Play

The VCR will play your recording over and over.



Push MENU to display the menu.

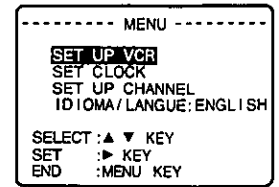

Push ▲▼ to select "SET UP VCR," and then push ► to display the "SET UP VCR" screen.

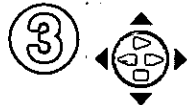

Push ▲▼ to select "REPEAT PLAY," and then push ► to select "ON" or "OFF."

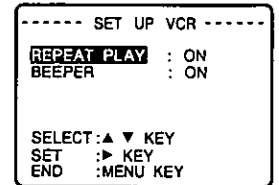

- The VCR plays back the tape to its end or until a blank portion of over 30 seconds is detected (erased portions are not considered blank). The tape is then rewound and played again and again until Repeat Play is turned off.



Push MENU twice to return to the normal screen.

One Minute Skip

The VCR rapidly skips over one minute of tape.



Push ZERO/ 1 MIN in Play mode.

- The VCR will go into FF search mode and skip over 60 seconds of recorded time. Normal playback will then resume.

Zero Search

To quickly return to a specific tape location.



Push DISPLAY to display the Time Counter overlay.

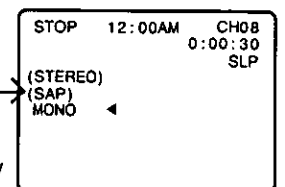

Model PV-7450 only



Push COUNTER RESET to reset the Time Counter to "0:00:00."

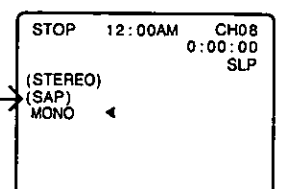

- This may be done at as many places as you wish on the tape.



Push ZERO/1MIN in Stop mode.

- The VCR will go into FF or REW mode and stop at the last point the Time Counter was set to 0:00:00.

VHS Index Search System

Each time you start a recording, an invisible index mark is automatically placed on the tape. You can then use these index marks to access or scan your recordings.

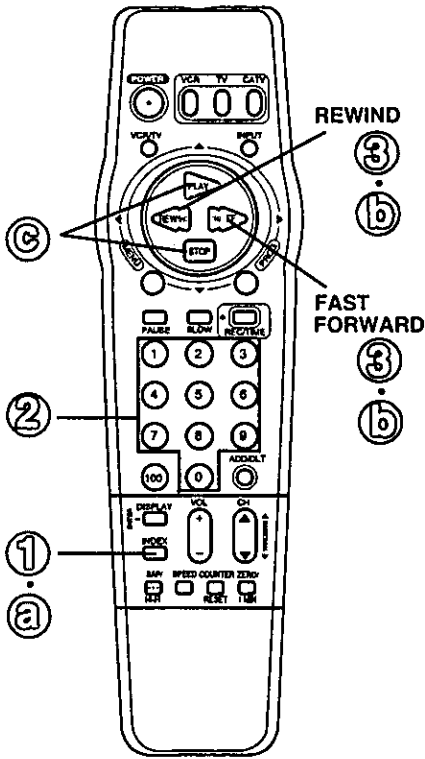
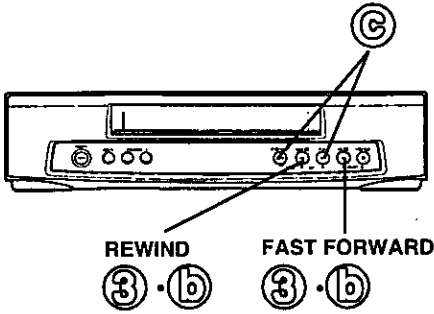

Model PV-7450 remote is shown here.



- Make each entry within 10 seconds, or the Index Search mode will be canceled.
- Index marks will be placed for Timer recordings as well.

• If the Direct Access index search is initiated extremely close to an index mark, there is a possibility that the index mark will not be counted in the search.

Direct Access

This feature allows you to go directly to the recording you want from anywhere on the tape by entering a specific index number.

① Push INDEX in Playback or Stop mode.

② Push a NUMBERED keys to select the desired recording.
• To calculate the number, see below.

③ or Push REW or FF to start the Index Search forward or backward.
• When the designated location is reached, the VCR goes into Playback mode.

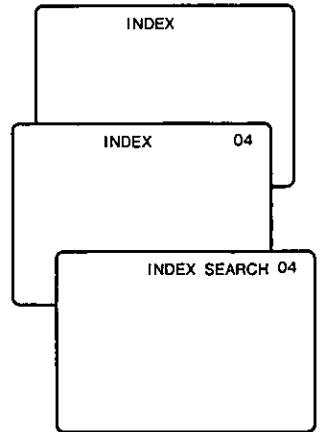

To calculate an Index Number

Count forward or backward each recording start point including the recording you want to see from wherever you are on the tape.

Example 1:

If you are watching recording 4 and you want to watch recording 2, count the start points to number 2. Recordings equal 3. Enter 3 in step "2" and push REW.

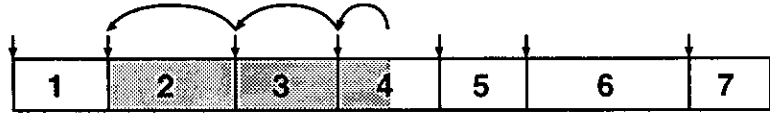

Example 2:

If you are watching recording 2 and you want to watch recording 6, count the start points to number 6. Recordings equal 4. Enter 4 in step "2" and push FF.

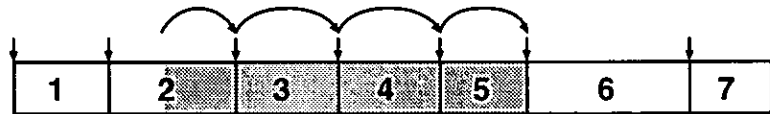

NOTE: ↓ indicates start points of each recording.

Index Scan

This feature allows you to scan (forward or reverse) each recording for 10 seconds in Playback mode.

a Push INDEX in Playback or Stop mode.

b or Push REW or FF to begin the scan.
• As each index mark is reached, a short playback will be performed after which FF or REW resumes.

c Push PLAY to cancel the scan and begin playback.
• You may also push STOP to stop the tape.

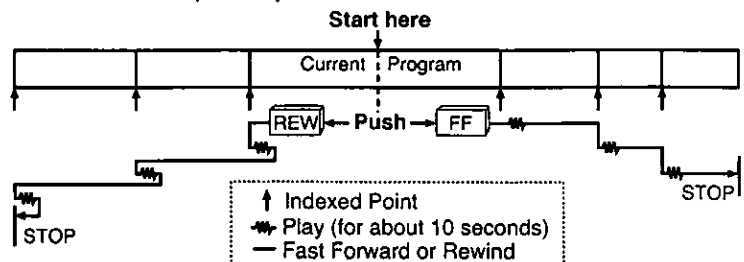
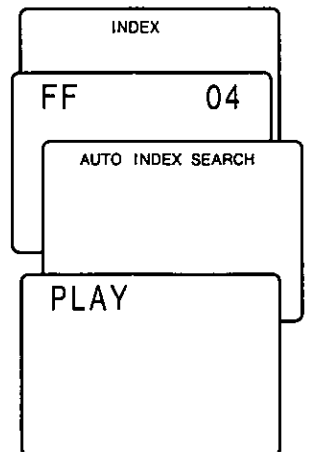

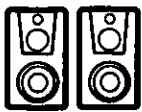

MTS Broadcast/ VHS Hi-Fi Stereo System

(For Model PV-7450 only)



Check list before you begin

- The VCR is connected to a stereo TV, or a mono TV and an external stereo amp or receiver with speakers.
- The VCR and other components are plugged in and turned on.

Connections to Make

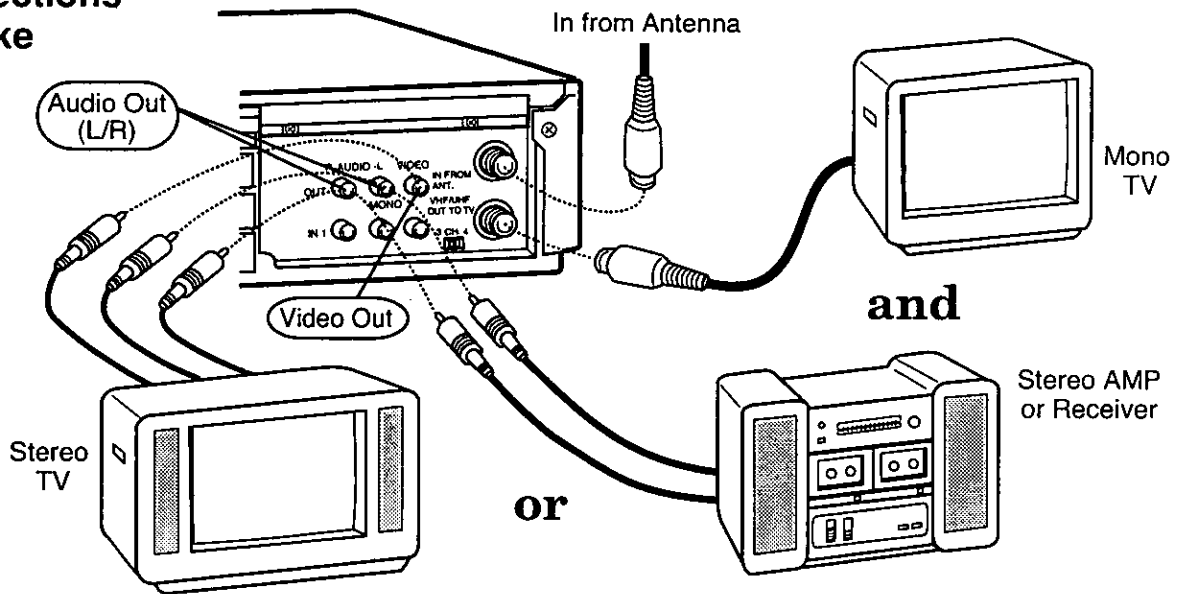

When recording, you may monitor in stereo, by connecting the VCR to either a stereo TV, or a mono sound TV with an external stereo amp and speakers.

Receivable Broadcast Types

The following are possible audio broadcast types and on-screen displays. Parenthesis indicate signal(s) not being received. The arrow indicates the selected audio mode.



Push DISPLAY to display the broadcast signal currently being received.

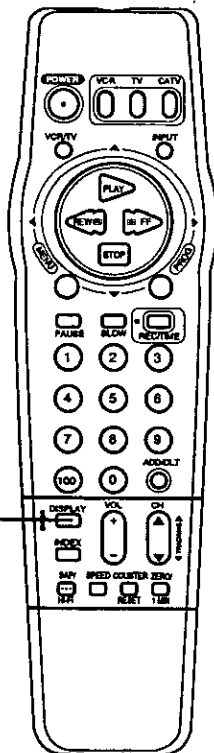

MTS Stereo and SAP broadcast

Multi-channel Television Sound Stereo (main language) and Secondary Audio Program (sub language) broadcasts are being received simultaneously. Select STEREO or SAP audio mode.

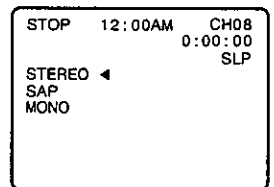

MTS Stereo broadcast

Multi-channel Television Sound Stereo broadcast. Select STEREO audio mode.
 • If a stereo broadcast is weak and the display flickers, you may want to select the MONO audio mode for better results.

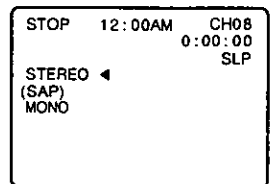

SAP broadcast

Secondary Audio Program (sub language) broadcast. Select SAP audio mode for the sub language.

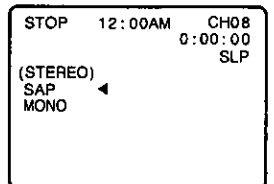

MONO broadcast

Normal monaural sound broadcast.

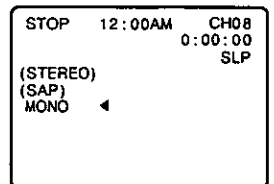

Equipped with **dbx**® -TV Noise Reduction for true MTS reproduction. **dbx**® -TV Noise Reduction is required for good stereo separation and audio fidelity. **dbx**® is a registered trademark, and is licensed by **dbx**® Technology Licensing.

With the proper audio mode setting, your VCR can:

- 1) record and playback an MTS stereo broadcast (main language) in stereo Hi-Fi.
- 2) record and playback a monaural broadcast (main language) or Secondary Audio Program (sub language) on the Hi-Fi tracks for better quality monaural sound.
- 3) playback non Hi-Fi tapes in monaural.

• When recording, the selected broadcast sound is always recorded on the left and right Hi-Fi tracks as well as the normal monaural track. This means your tapes can be played back on Hi-Fi as well as non-Hi-Fi VCRs.

Audio Mode for Recording

1



Push SAP/Hi-Fi repeatedly (each push within 5 seconds) to select the desired audio mode (STEREO, SAP, or MONO).

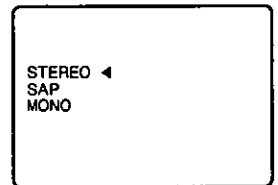

• The arrow indicates your selection.

• Please refer to the "Receivable Broadcast Types" section on page 22.

2

Do a recording.
See the "Record On a Tape" section on page 16.

Audio Mode for Playback

a

Playback the tape.
See the "Playback a Tape" section on page 15.

b



Push SAP/Hi-Fi repeatedly (each push within 5 seconds) to select the desired audio mode (HIFI or NORMAL).

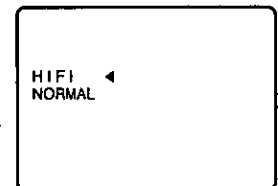

• The arrow indicates your selection.

• Select "HIFI" to listen to your stereo recordings with stereo sound, or NORMAL for monaural sound.

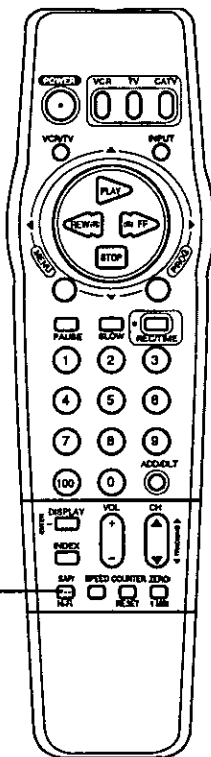

1
b



- When purchasing or renting prerecorded tapes, remember that only those recorded in Hi-Fi stereo will play back with true stereo sound. Standard stereo tapes will play back with monaural sound.
- In order to listen to Hi-Fi stereo playback, the VCR AUDIO (L/R) jacks must be connected to a stereo TV or an external stereo amp and speakers. (See page 22.)
- When adjusting the tracking during playback, the Hi-Fi audio sound may revert to normal audio sound. This is normal.
- There may be a difference in audio level between Hi-Fi and normal audio playback.

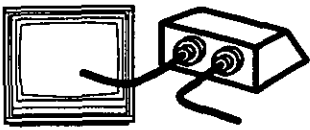

Multi-Brand Control Feature

The Remote Control may be set up to control some of the functions on your TV or Cable Box.

TV Brand Code Numbers

| | | | | | |
|-----------------|--------|----------------|--------|------------------|------------|
| Panasonic | 01, 02 | Sylvania | 05 | JVC | 11 |
| Quasar | 01, 02 | Sharp | 06, 07 | Hitachi | 12 |
| RCA | 03 | Sony | 08 | Mitsubishi | 07, 13 |
| GE | 03 | Toshiba | 09 | Samsung | 14 |
| Zenith | 04 | Sanyo | 10 | Gold Star | 15, 16, 17 |
| Magnavox | 05 | Fisher | 10 | | |

Cable Box Brand Code Numbers

| | |
|---|--------------------------------|
| Archer | 01, 29, 44, 88, 91 |
| Cableview ... | 04, 30, 42, 44, 52, 63, 85, 88 |
| Citizen | 04, 30, 42, 44, 52, 63, 85, 88 |
| Curtis | 08, 09, 56, 61, 87, 90 |
| Diamond | 01, 29, 44, 88, 91 |
| Drake | 37, 67, 71 |
| Eagle | 13, 20, 22, 26, 40, 58, 62, 98 |
| Eastern | 28 |
| GC Brand ... | 04, 30, 42, 44, 52, 63, 85, 88 |
| Gemini | 04, 85 |
| General Electric | 57 |
| General Instruments | |
| . 01, 02, 03, 04, 34, 55, 83, 85, 91, 93, 95 | |
| Hamlin | 14, 15, 28, 41, 97, 100, 102 |
| Hitachi | 31, 79 |
| Jerrold | |
| . 01, 02, 03, 04, 34, 55, 83, 85, 91, 93, 95 | |
| Macom | 31, 79 |
| Magnavox | 25, 26 |
| Matsushita | 16, 17, 101 |
| Movietime ... | 29, 32, 38, 39, 40, 42, 44, 88 |
| NSC | 32, 38, 40 |
| Oak | 10, 11, 46, 99 |
| Panasonic | 16, 17, 101 |
| Philips | 13, 20, 23, 24, 96 |
| Pioneer | 05, 06, 78 |
| Pulser | 04, 30, 42, 44, 52, 63, 85, 88 |
| Radio Shack | 44 |
| RCA | 16, 17, 101 |
| Realistic | 44, 51, 88 |
| Regal | 14, 41 |
| Regency | 28 |
| Rembran | 29, 32, 39, 42, 44, 88 |
| Salora | 68, 72 |
| Samsung | 32, 40, 42, 78, 94 |
| Scientific Atlanta | 08, 09, 56, 61, 87, 90 |
| Sheritech | 27 |
| SL Marx | 32, 40, 42, 78, 94 |
| Spucer | 16, 17, 101 |
| Stargate | |
| .. 04, 30, 32, 40, 42, 44, 52, 63, 78, 85, 88, 94 | |
| Sylvania | 19 |
| Teknika | 74 |
| Telecaption | 77, 92 |
| Televue | 32, 40, 42, 78, 94 |
| Texscan | 18, 19 |
| Tocom | 01, 33, 34, 42, 48, 49, 91 |
| Toshiba | 36 |
| Uniden Satellite | 65, 69 |
| Unika | 01, 29, 44, 88, 91 |
| Universal | 42, 43, 44, 52, 63, 88 |
| Viewstar | 13, 20, 22, 26, 40, 58, 62, 98 |
| Videoway | 07, 23, 50 |
| Vid Tech | 64 |
| Vidter | 64 |
| Zenith | 07, 23, 50 |

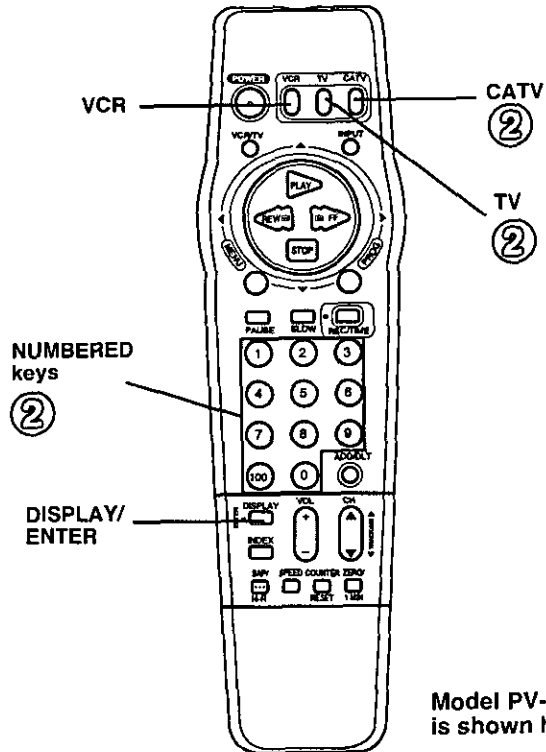

Model PV-7450 remote is shown here.

Universal Remote Control Setup

① Find your TV or Cable Box Brand Code Number from the chart at left.

② Hold down TV or CATV. Use the NUMBERED keys to enter your TV or Cable Box Brand code number.

• For code numbers 100 or greater, first push the 100 key. Then, enter the remaining digit. E.g. for 102, push 100, then push 2.

③ Try each of the functions on page 25.

• Due to changes in infra-red commands used by some manufacturers, some TV or Cable Box brands are listed more than once. If your TV or Cable Box does not respond to the first code, please try entering the next code.



• Please repeat the TV/Cable Box Set Up procedure when you replace the remote's batteries.

• The remote control is designed to control the brands listed. However, it will not operate all TVs or Cable Boxes made by these manufacturers. If you get no results, your particular product brand cannot be controlled by this remote.

Using the Universal Remote Control

Once the remote control has been properly set up, you can select VCR, TV, or CATV mode depending on which functions you wish to control.



Push VCR or TV or CATV on the remote control to select the desired mode.
(See below for the controllable functions of each mode.)

NOTE:

In TV or CATV mode, it may be necessary to push DISPLAY/ENTER after pushing NUMBERED keys for channel selection.

VCR Mode

In VCR mode, the following buttons are available.

VCR

All function buttons.

TV

VOL UP/DOWN

TV Mode

In TV mode, the following buttons are available.

TV

POWER, INPUT, NUMBERED keys, DISPLAY/ENTER, CH UP/DOWN, VOL UP/DOWN

VCR

VCR/TV, PLAY, STOP, FF, REW, PAUSE, SLOW, REC, SAP/Hi-Fi, SPEED, COUNTER RESET, ZERO/1 MIN.

CATV Mode

In CATV mode, the following buttons are available.

CATV

POWER, NUMBERED keys, DISPLAY/ENTER, CH UP/DOWN

TV

VOL UP/DOWN

VCR

VCR/TV, PLAY, STOP, FF, REW, PAUSE, SLOW, REC, SAP/Hi-Fi, SPEED, COUNTER RESET, ZERO/1 MIN.

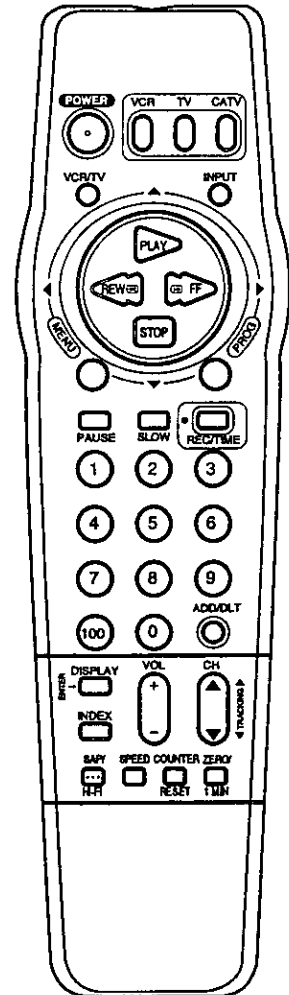
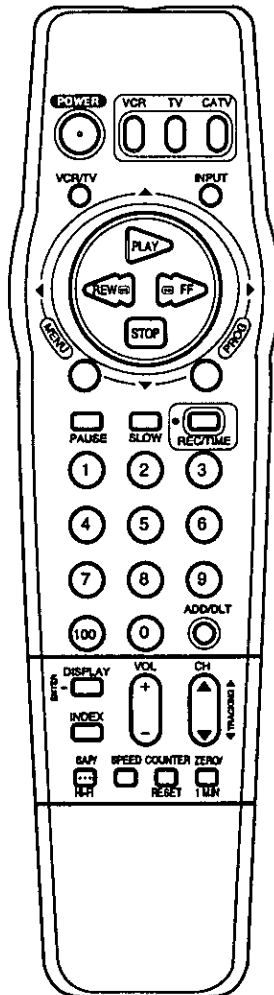
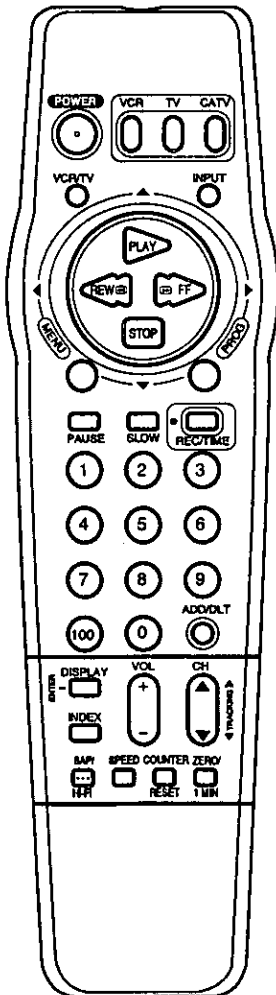

Model PV-7450 remote is shown here.



- Some TV and Cable Box brands require you to turn on the power manually.
- Not all functions listed may be controlled by this remote control.

More You Can Do



Special VCR Features



Check list before you begin.

- All connections are made. (See pages 6~9.)
- VCR is Plugged in.
- TV is turned on and set to the VCR channel (CH3 or CH4).

VCR Lock Feature

When activated, this feature prohibits all operations except for timer recording and tape eject. This feature is used to keep children from operating the VCR.

Hold down STOP/EJECT on the VCR for 7 seconds while in Stop or Power OFF mode.

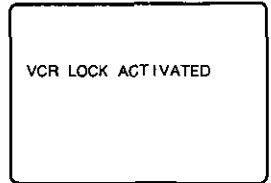

To Cancel the VCR Lock feature,

hold down STOP/EJECT on the VCR for 7 seconds again while in Stop or Power OFF mode.

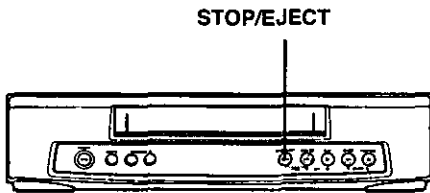
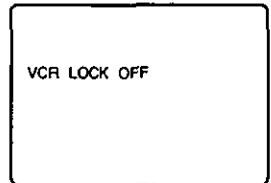

- VCR Lock mode is cancelled automatically after 24 hours as long as the clock is set.

Warning Beeper Feature

When you select BEEPER ON as described below, a short warning will sound each time an invalid entry or incomplete operation is made.

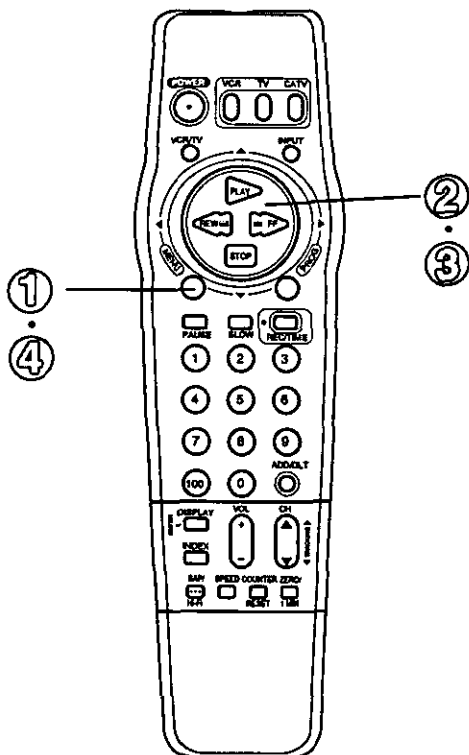

Model PV-7450 remote is shown here.

1 Push MENU to display the menu.

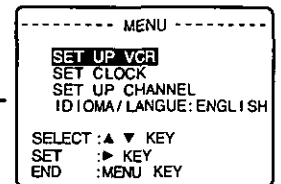

2 Push ▲▼ to select "SET UP VCR," and then push ► to display the "SET UP VCR" screen.

3 Push ▲▼ to select "BEEPER," and then push ► to select "ON" or "OFF."

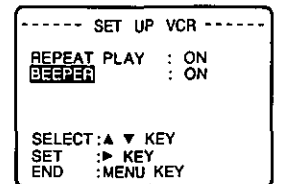

4 Push MENU twice to exit this screen.



Before Requesting Service

Check the following points once again if you are having trouble with your VCR.

| Power | Correction |
|---|---|
| No power... | <ul style="list-style-type: none"> • Completely insert the Power Plug into an AC outlet. • Set the POWER button to ON. |
| Recording & Playback | Correction |
| TV program cannot be recorded... | <ul style="list-style-type: none"> • Check connections between VCR, external antenna, and your TV. • Make sure your antenna system (CATV or TV) is connected correctly. (To Replace Channels in Memory [P.13]) • Make sure that the record tab is intact on the cassette. (P.5) |
| Timer recording cannot be performed... | <ul style="list-style-type: none"> • Set the recording start/stop times correctly. (P.18) • Make sure that the POWER button is set to OFF. (P.18) • Timer recording may not be performed or continued if a power interruption of more than 1 minute occurs before or during, a Timer Recording, even if power resumes thereafter. |
| There is no playback picture, or the playback picture is noisy or contains streaks.. | <ul style="list-style-type: none"> • Select channel 3 or 4 on the TV to match the Channel 3/4 switch located on the rear panel of the VCR. (P.6) • Set the VCR/TV selector to "VCR". • Check that channel 3 or 4 of the TV is properly adjusted. • Adjust the TRACKING control in either direction. (P.15) |
| Special effects playback, picture may contain some vertical jitter when using a TV with an Automatic Vertical Hold Control... | <ul style="list-style-type: none"> • Set the TV's Vertical Hold Control to "MANUAL" and then adjust it. |
| VCR can't be controlled... | <ul style="list-style-type: none"> • Make sure that VCR LOCK is set to off. (P.26) |
| Remote Control | Correction |
| VCR cannot be remote controlled... | <ul style="list-style-type: none"> • Aim the Remote Control directly at the remote sensor on the VCR. (P.10) • Avoid all obstacles which may interfere with the signal path. • Inspect the remote batteries for possible replacement. (P.4) • Make sure that VCR LOCK is set to off. (P.26) • Exposing the VCR remote sensor to direct fluorescent or outdoor light may cause signal interference. |
| The MENU and PROG buttons can't be used. | <ul style="list-style-type: none"> • Push the VCR button to select VCR mode. (P.25) |
| Miscellaneous | Correction |
| Programs cannot be viewed on TV... | <ul style="list-style-type: none"> • Set the VCR/TV selector to "TV". (P.16) |
| Video cassette cannot be inserted... | <ul style="list-style-type: none"> • Insert cassette with window side up and the record tab facing you. |
| Video cassette cannot be removed... | <ul style="list-style-type: none"> • Completely insert the Power Plug into an AC wall outlet. |
| Video cassette ejects when a recording is started or the power is turned off for timer recording... | <ul style="list-style-type: none"> • Make sure the record tab is intact on the cassette. (P.5) |
| In Stop mode, the motor (CYLINDER) continues to rotate... | <ul style="list-style-type: none"> • To enable the quick play mechanism, the cylinder will rotate for about 5 minutes. This reduces response time from Stop to Play mode from Play to Rewind Search mode. |
| The top of the playback picture waves back and forth excessively... | <ul style="list-style-type: none"> • Because the VCR playback signal is not as stable as an off-the-air TV signal, the top of your TV screen may be bent or unstable during playback. To solve this problem, slowly turn the horizontal hold control on your TV to correct the wavy picture. If your TV does not have a horizontal hold control or adjusting the control does not help, please contact your local TV service center. |

If you cannot resolve your problem, please call the Customer Satisfaction Center for product assistance at 201-348-9090.

To locate an authorized servicenter, please call toll free 1-800-545-2672.

Service Center List

PRODUCT INFORMATION • OPERATION ASSISTANCE • LITERATURE REQUESTS • DEALER LOCATIONS

Customer Service Center 2F-3, One Panasonic Way, Secaucus, NJ 07094 (Headquarters)
201-348-9090 (9:00am-8:00pm Monday-Friday, EST)

ACCESSORY PURCHASES

Panasonic Services Company 20421 84th Avenue South Kent, WA 98032
(6 am to 6 pm Monday - Friday ; 6 am to 10:30 am Saturday ; PST)
(Visa, Mastercard, Discover card, American Express, Check)

AUTHORIZED SERVICENTERS • PARTS DISTRIBUTOR LOCATIONS

To locate an independent authorized servicer or parts distributor in your area,
within the USA dial toll free 1-800-545-2672, 24 hours a day, 7 days a week.

PRODUCT REPAIRS

CALIFORNIA

6550 Katella Avenue
Cypress, CA 90630
Phone (714) 373-7425
Fax (714) 894-8534

800 Dubuque Avenue
S. San Francisco, CA 94080
Phone (415) 871-6373
Fax (415) 871-6840

20201 Sherman Way
Suite 102
Canoga Park, CA 91306
Phone (818) 709-1775
Fax (818) 709-2165

3878 Ruffin Road
Suite A
San Diego, CA 92123
Phone (619) 560-9200
Fax (619) 560-1831

COLORADO
1640 South Abilene Suite D
Aurora, CO 80012
Phone (303) 752-2024
Fax (303) 752-0610

FLORIDA
3700 North 29th Avenue
Suite 102
Hollywood, FL 33020
Phone (954) 925-2880
Fax (954) 925-5224

4710 Eisenhower Boulevard
Suite A1
Tampa, FL 33634
Phone (813) 884-4746
Fax (813) 886-4564

Factory Servicenters

GEORGIA

8655 Roswell Road
Suite 100
Atlanta, GA 30350
Phone (770) 518-6301
Fax (770) 518-6306

HAWAII

99-859 Iwaiwa Street
Aiea, Hawaii 96701
Phone (808) 488-4369
Fax (808) 486-4369

ILLINOIS

1703 North Randall Road *
Elgin, IL 60123
*12:30 to 4:30, Mon-Fri
Phone (847) 468-5464
Fax (847) 468-5465

9060 Golf Road
Niles, IL 60714
Phone (847) 608-1010
Fax (847) 299-1710

MARYLAND

Sulphur Springs
Business Park
1638 Sulphur Springs Road
Baltimore, MD 21227
Phone (410) 242-2607
Fax (410) 247-3047

MASSACHUSETTS

60 Glacier Drive, Suite G
Westwood, MA 02090
Phone (617) 329-4280
Fax (617) 329-0586

*pick-up/drop-off only

MICHIGAN

37048 Van Dyke Avenue
Sterling Heights, MI 48312
Phone (810) 939-2060
Fax (810) 939-2638

MINNESOTA

7850-12th Avenue South
Airport Business Center
Bloomington, MN 55425
Phone (612) 854-8624
Fax (612) 854-2089

OHIO

2236 Waycross Road
Cincinnati, OH 45240
Phone (513) 851-4180
Fax (513) 851-8443

PENNSYLVANIA

2221 Cabot Boulevard West
Suite B
Langhorne, Pa 19047
Phone (215) 741-0661
Fax (215) 741-0521

Chartiers Valley Shopping
Center

1025 Washington Pike
Bridgeville, PA 15017
Phone (412) 257-4522
Fax (412) 257-4650

TENNESSEE

919-8th Avenue South
Nashville, TN 37203
Phone (615) 244-4434
Fax (615) 244-6713

TEXAS

7482 Harwin Drive
Houston, TX 77036
Phone (713) 781-1528
Fax (713) 781-0643

13615 Welch Road
Suite 101
Farmers Branch, TX 75244
Phone (214) 385-1975
Fax (214) 960-7626

WASHINGTON

20425-84th Avenue South
Kent, WA 98032
Phone (206) 872-7922
Fax (206) 872-0918

Service in Puerto Rico

Matsushita Electric
of Puerto Rico, Inc.
Panasonic Sales Company/
Factory Servicer
Ave. 65 de Infantería, Km. 9.5
San Gabriel Industrial Park
Carolina, Puerto Rico 00985
Phone (809) 750-4300
Fax (809) 768-2910

REPAIR INQUIRIES

EAST (PCE)

2221 Cabot Boulevard West
Suite A
Langhorne, PA 19047
Phone (215) 741-0676
Fax (215) 750-6492

Covers:

CT, DE, ME, MD, MA, NH, NJ,
NY, PA, RI, VT, VA, DC, WV

Regional Customer Care Department

EAST (PCE)

1225 Northbrook Parkway
Suite 2-390
Suwanee, GA 30174
Phone (770) 338-6860
Fax (770) 338-6548

Covers:

AL, FL, GA, MS, NC, SC, TN

CENTRAL (PCC)

1707 North Randall Road
Elgin, IL 60123
Phone (847) 468-5530
Fax (847) 468-5528

Covers:

AR, IL, IN, IA, KS, KY, LA,
MI, MN, MO, NE, ND, OK,
SD, TX, WI, OH

WEST (PCW)

6550 Katella Avenue
Cypress, CA 90630
Phone (714) 373-7440
Fax (714) 373-7447

Covers:

AK, AZ, CA, CO, ID, MT, NV,
NM, OR, UT, WA, WY, HI

Warranty

Panasonic Consumer Electronics Company,
Division of Matsushita Electric Corporation
of America,
One Panasonic Way
Secaucus, New Jersey 07094

Panasonic Sales Company,
Division of Matsushita Electric of Puerto Rico, Inc.
AVE. 65 de Infantería, Km. 9.5
San Gabriel Industrial Park
Carolina, Puerto Rico 00985

PANASONIC Video Products Limited Warranty

Panasonic Consumer Electronics Company or Panasonic Sales Company (collectively referred to as "the Warrantor") will repair this product with new or refurbished parts, free of charge, in the USA or Puerto Rico, in the event of a defect in materials or workmanship as follows (all time periods commence from the date of the original purchase):

| PRODUCT | PARTS | |
|-------------|---|--|
| CAMCORDER | ONE (1) YEAR, EXCEPT CCD IMAGE SENSOR CCD IMAGE SENSOR - SIX (6) MONTHS | NINETY (90) DAYS NINETY (90) DAYS |
| VCR | ONE (1) YEAR | NINETY (90) DAYS |
| A/V MIXER | ONE (1) YEAR | NINETY (90) DAYS |
| MONITOR-VCR | ONE (1) YEAR, EXCEPT CRT CRT - TWO (2) YEARS | NINETY (90) DAYS CRT LABOR ONE (1) YEAR SECOND YEAR CUSTOMER PAYS ALL LABOR CHARGES |

Monitor-VCR In-home or carry-in Service: 19" (diagonal) CRT / LCD and Larger
Monitor-VCR Carry-in Service: 18" (diagonal) CRT / LCD and smaller

Batteries (if included) - New rechargeable batteries in exchange for defective rechargeable batteries for ten (10) days from the date of original purchase. Non-rechargeable batteries are not warranted.

Tape (if includes) - New video cassette tape in exchange for a defective video cassette tape for five (5) days from the date of the original purchase.

In-home, carry-in or mail-in service, as applicable, in the USA can be obtained during the warranty period by contacting a Panasonic Services Company (PASC) Factory Servicenter listed in the Service Directory. Or call 1-800-545-2672, toll free, to locate an authorized PASC Servicenter. Carry-in or mail-in service in Puerto Rico can be obtained during the warranty period by calling the Panasonic Sales Company telephone number listed in the Servicenter Directory.

This warranty is extended only to the original purchaser. A purchase receipt or other proof of the date of the original purchase is required before warranty service is rendered.

This warranty only covers failures due to defects in materials and workmanship which occur during normal use and does not cover normal maintenance, including, but not limited to, video and audio head cleaning. The warranty does not cover damage which occurs in shipment, or failures which are caused by products not supplied by the warrantor, or failures which result from accident, misuse, abuse, neglect, mishandling, misapplication, alteration, modification, faulty installation, set-up adjustments, improper antenna, inadequate signal pickup, maladjustment of consumer controls, improper operation, power line surge, lightning damage, commercial use such as hotel, office, restaurant, or other business or rental use of the product, or serviced by anyone other than a PASC Factory Servicenter or an authorized PASC Servicenter, or damage that is attributable to acts of God.

LIMITS AND EXCLUSIONS

There are no express warranties except as listed above.

THE WARRANTOR SHALL NOT BE LIABLE FOR INCIDENTAL OR CONSEQUENTIAL DAMAGES (INCLUDING, WITHOUT LIMITATION, DAMAGE TO TAPES) RESULTING FROM THE USE OF THIS PRODUCTS, OR ARISING OUT OF ANY BREACH OF THE WARRANTY. ALL EXPRESS AND IMPLIED WARRANTIES, INCLUDING THE WARRANTIES OF MERCHANTABILITY AND FITNESS FOR PARTICULAR PURPOSE, ARE LIMITED TO THE APPLICABLE WARRANTY PERIOD SET FORTH ABOVE. Some states do not allow the exclusion or limitation of incidental or consequential damages, or limitations on how long an implied warranty lasts, so the above exclusions or limitations may not apply to you.

This warranty gives you specific legal rights and you may also have other rights which vary from state to state.

If a problem with this product develops during or after the warranty period, you may contact your dealer or Servicenter. If the problem is not handled to your satisfaction, then write to the Customer Satisfaction Center at the Panasonic Consumer Electronics Company address above.

SERVICE CALLS WHICH DO NOT INVOLVE DEFECTIVE MATERIALS OR WORKMANSHIP AS DETERMINED BY THE WARRANTOR. IN ITS SOLE DISCRETION, ARE NOT COVERED. COSTS OF SUCH SERVICE CALLS ARE THE RESPONSIBILITY OF THE PURCHASER.

warvid 8/20/96

Para fijar el idioma, canal y reloj

- 1** Encienda el televisor y la videgrabadora.



- 2** Sintonice el televisor al canal de salida de la videgrabadora (el mismo canal que ha fijado en la parte trasera de la videgrabadora; canal 3 o 4).

- 3** Oprimir CH ▲ para elegir el idioma de la pantalla en inglés.



Oprimir CH ▼ para elegir el idioma de la pantalla en español.



Oprimir VCR/TV para elegir el idioma de la pantalla en francés.



SELECT LANGUAGE

PUSH VCR CH ▲: ENGLISH
PULSE VCR CH ▼: ESPAÑOL
APP. VCR/TV : FRANÇAIS

• Ud. podrá fijar también usando los mismos botones que están ubicados en la videgrabadora.

 - La videgrabadora debe conectarse a una antena o caja de TV por cable.
 - Si está usando una caja de TV por cable, deje encendido para la fijación automática.

- 4** Oprimir VCR CH ▲ para iniciar la fijación automática de los canales.



Aparece las siguientes informaciones:
"POR FAVOR FIJE RELOJ CON LA TECLA MENU"

- 5** Oprimir MENU para que aparezca la pantalla de fijación del reloj.



FIJAR RELOJ

VERANO:ACT

ELEGIR MES

ELEGIR:▲▼
FIJAR:▶
TERMINAR:MENU

 - Introduzca los datos en 5 minutos o la videgrabadora saldrá de la pantalla de la fijación del reloj.

- 6** Oprimir ▲▼ para elegir el mes y luego oprimir ▶ para fijar el mes.



FIJAR RELOJ

VERANO:ACT

ELEGIR MES

ELEGIR:▲▼
FIJAR:▶
TERMINAR:MENU

- 7** Oprimir ▲▼ y ◀▶ para elegir y fijar las fijaciones restantes que están a la derecha.



Fijaciones:

 - Fecha
 - Año
 - Hora
 - Verano (Hora veraniega)

- 8** Oprimir MENU dos veces para iniciar a funcionar el reloj y salir desde este modo.



FIJAR RELOJ

17/4/1997 SAB 12:00PM

VERANO:ACT

FIJACION ES COMPLETO

FIJAR:◀▶
INICIAR:MENU

Fijación o cambio de la hora

En caso de que el reloj está incorrecto o ha ocurrido un corte eléctrico.

- 1** Oprimir MENU para que aparezca la pantalla del menú.
 - 2** Oprimir ▲▼ para elegir "FIJAR RELOJ" y luego oprimir ▶ para que aparezca la pantalla de "FIJAR RELOJ."
 - 3** Oprimir ▲▼ y ◀▶ para elegir y fijar la hora y el día.
 - 4** Oprimir MENU dos veces para iniciar a funcionar el reloj y salir desde este modo.
- MENU -----

PREPARAR VCR
FIJAR RELOJ
FIJAR CANAL
LANGUE/LANGUAGE: ESPANOL

ELEGIR:▲▼
FIJAR:▶
TERMINAR:MENU
- FIJAR RELOJ-----

17/4/1997 SAB 12:00PM



VERANO:ACT

FIJACION ES COMPLETO

ELEGIR:▲▼
FIJAR:▶
TERMINAR:MENU

Operaciones básicas para la reproducción

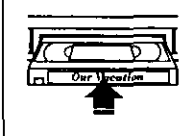
- 1** Introducir una cinta





Esta indicación aparece en la pantalla multifuncional.

- 2** Oprimir PLAY en el control remoto o en la videgrabadora para comenzar a reproducir.

 - Si la cinta no tiene la lengüeta para evitar el borrado la videgrabadora comienza a reproducir automáticamente.



- 3** Oprimir STOP en el control remoto o en la videgrabadora para parar la reproducción.



- 4** Oprimir STOP/EJECT para expulsar la cinta.

 - Usted puede expulsar la cinta cuando el aparato está encendido o apagado.

Para buscar una escena en particular durante la reproducción

- Oprimir REW o FF durante la reproducción para buscar una escena.
- 
- 

- La velocidad de búsqueda es a 9 veces más rápida que la velocidad normal para el modo SP (sólo los modelos PV-7400 y PV-7450) y 27 veces más rápida para el modo SLP.
- Durante la búsqueda aparece alguna barra de ruido.

Operaciones básicas para la grabación

1 Introducir una cinta con la lengüeta.

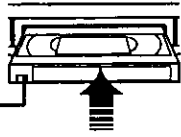

- La videograbadora se enciende automáticamente.

2 Oprimir CH ▲/▼ o las teclas numéricas para elegir el canal.

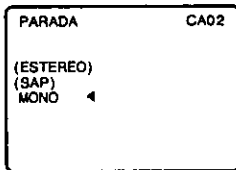
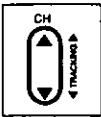

- U oprimir CH ▲/▼ en la videograbadora.
- Para grabar desde una fuente externa, oprimir CH ▲/▼ o INPUT para seleccionar "LINEA."

3 Oprimir SPEED para cambiar la velocidad de la cinta.

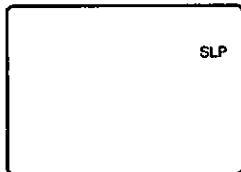
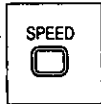

- SP = Reproducción estándar,
- LP = Larga duración,
- SLP = Superlarga duración.

4 Oprimir REC/TIME en el control remoto o videograbadora para empezar a grabar.



- Oprimir PAUSE para hacer una pausa en la grabación en progreso.

Grabación de un toque (OTR)

La videograbadora termina la grabación a una hora programada.

En el paso 4, oprimir repetidamente REC/TIME para fijar el tiempo de grabación. Cada presión cambiará la hora de parada como demuestra al siguiente.

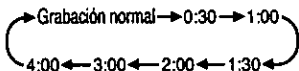

- La indicación TIMER aparece en la pantalla multifuncional.
- El tiempo de la grabación que sobra se podrá exhibir en el modo de OTR.

5 Oprimir STOP para parar la grabación.

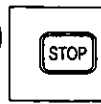

- U oprimir STOP/EJECT en la videograbadora.

Programación fácil para la grabación con temporizador

1 Oprimir PROG para exhibir la pantalla de la programación.

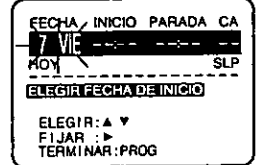

- Si ya existe una programación memorizada, oprima ▲▼ y ► para elegir un número sin programación.

2 Oprimir ▲▼ y ► para elegir y fijar uno de los siguientes:



- 1~31 = Grabación de una sola vez
- DIARIO = A una misma hora LUN~VIE
- SEMANAL = Una vez a la semana a una misma hora

Ejemplo

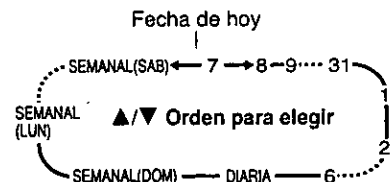

3 Oprimir ▲▼ and ◀▶ para elegir y fijar las siguientes fijaciones.

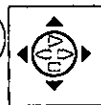

- Fijaciones:**
- Hora de inicio.
 - Hora de parada.
 - Canal o LINEA para una fuente externa.
 - Velocidad de la cinta (SP, LP, SLP).

Para hacer correcciones

Oprimir ► sucesivamente para avanzar u ◀ para retroceder hasta el paso que desea corregir.

4 Oprimir PROG para terminar la programación.

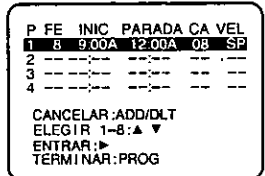
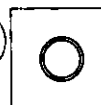

Para hacer más programaciones

Oprimir ▲▼ y ► para elegir y fijar un número de programa en blanco y luego repita los pasos 2 y 3.

5 Oprimir PROG para salir desde este modo y volver a la pantalla normal.



6 Oprimir POWER para apagar el aparato para la grabación con temporizador.

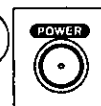

Pantalla multifuncional



- Si la fuente de la grabación es una caja de TV por cable, asegúrese de que la caja de TV por cable esté encendido y esté sintonizado al canal que desea grabar.

Quick Use Guide

This guide should only be used once you are familiar with the operations inside this manual. If you have any problems or need more information, please refer to the page listed.

Clock Reset (page 13)

Display the menu

```

MENU
-----
SET UP VCR
SET CLOCK
SET UP CHANNEL
ID TONA / LANGUE: ENGL I SH
SELECT: ▲ ▼ KEY
SET   : ▶ ◀ KEY
END   : MENU KEY
    
```

Select "SET CLOCK"

```

SET CLOCK
-----
1 / 4 / 1997 SAT 12:00PM
OBT: ON
SELECT HOUR
SELECT: ▲ ▼ KEY
SET   : ▶ ◀ KEY
END   : MENU KEY
    
```

Set the clock

Start the clock & exit this mode

Playback a Tape (page 15)

Turn TV on
Select VCR
Channel 3/4

Insert a tape

Start playback

Stop playback

At VCR
STOP/EJECT
Eject tape

Make a Recording (page 16)

Turn TV on
Select VCR
Channel 3/4

Insert a tape
with Record Tab

Select channel

Select speed

Start recording

Stop recording

Set a Timer Recording (page 18)

Display the program screen

```

DATE / START STOP CH
7 FRI  --:--  --:--  --
10:00  12:00  08  SP
-----
fobdy
SELECT START DATE
SELECT: ▲ ▼ KEY
SET   : ▶ ◀ KEY
END   : PROG KEY
    
```

Enter timer information

Once to finish the program, twice to exit this mode

```

P DT START STOP CH SPD
1 DAY  9:00A 12:00A 08  SP
2
3
4
-----
CANCEL: ADD/OLT KEY
SELECT 1-8: ▲ ▼ KEY
ENTER  : ▶ KEY
END    : PROG KEY
    
```

Turn VCR off to set the timer

Panasonic Consumer Electronics
Company, Division of Matsushita
Electric Corporation of America
One Panasonic Way Secaucus,
New Jersey 07094

Panasonic Sales Company,
Division of Matsushita Electric of
Puerto Rico, Inc. ("PSC")
Ave. 65 de Infantería. Km. 9.5
San Gabriel Industrial Park, Carolina,
Puerto Rico 00985